



# Technical White Paper on the SmartWi-Fi 4K Video Transmission Solution



Building Home Networks with  
High-Quality 4K Video Experience



**Copyright © Huawei Technologies Co., Ltd. 2018. All rights reserved.**

No part of this document may be reproduced or transmitted in any form or by any means without prior written consent of Huawei Technologies Co., Ltd.

#### Trademark Notice

 **HUAWEI**, and  are trademarks or registered trademarks of Huawei Technologies Co., Ltd. Other trademarks, product, service and company names mentioned are the property of their respective owners.

#### General Disclaimer

The information in this document may contain predictive statements including, without limitation, statements regarding the future financial and operating results, future product portfolio, new technology, etc. There are a number of factors that could cause actual results and developments to differ materially from those expressed or implied in the predictive statements. Therefore, such information is provided for reference purpose only and constitutes neither an offer nor an acceptance. Huawei may change the information at any time without notice.

**HUAWEI TECHNOLOGIES CO., LTD.**

Huawei Industrial Base  
Bantian Longgang  
Shenzhen 518129, P.R. China  
Tel: +86-755-28780808

[www.huawei.com](http://www.huawei.com)

iLab

# CONTENTS

<b>01</b>	Introduction	01	
<b>02</b>	4K Video Standards and Transmission Technology Requirements	03	2.1 4K Video Standards 2.2 4K Transmission Technology Requirements
<b>03</b>	Challenges of 4K over Wi-Fi	11	3.1 4K Video Bit Rate 3.2 4K Live TV Principles 3.3 4K VOD Principle 3.4 Wi-Fi Transmission Principles 3.5 Challenges of 4K over Wi-Fi
<b>04</b>	Key Features of 4K over Wi-Fi	21	4.1 Specifications Requirements on Home Gateways and APs 4.2 Performance Improvement of Home Wi-Fi Networks 4.3 Maintainability and Manageability 4.4 4K over Wi-Fi Solution
<b>05</b>	Deployment Suggestions for Typical Scenarios	33	5.1 Huawei SmartWi-Fi Home Network Solution Product Portfolio 5.2 Small Household (1–2 Rooms) 5.3 Large Household (3–5 Rooms) 5.4 Skip-Floor Villa
<b>06</b>	Test Standards for 4K over Wi-Fi	35	6.1 Test Method 6.2 Typical Test Scenarios
<b>07</b>	Outlook	38	
<b>08</b>	References	39	
<b>09</b>	Acronyms and Abbreviations	40	





# 01 Introduction

With the rapid development of Internet of Things (IoT), cloud computing, big data, and ultra-broadband, services such as 4K, virtual reality (VR), and smart home applications are booming under the background of "Internet+". Wi-Fi gradually becomes a rigid demand for broadband users. Data indicates that 80% traffic of the current carriers comes from Wi-Fi and most of the traffic is generated by video services, which is mainly consumed in home scenarios. This is a market opportunity for new business models of carriers.

From the perspective of communication, the ear is the entrance of hearing and connects to the voice era, and eyes are the entrance of vision and connect to the video era. In the digital era, only 64 kbit/s network bandwidths are required to transmit clear voice, but more than 10 Mbit/s network bandwidths are required to transmit high definition (HD) video services alone. To date, audio services have developed to the extreme, and immersive audio of 20 Hz to 20 kHz has reached the limit of human hearing. Videos are developed from black-and-white to colored, from standard definition (SD) to HD, and to 4K, 8K, augmented reality (AR), and VR. Video requirements are far from being satisfied. In the era of information explosion, video is the main medium of information, and video demand is global.

With the rapid development of terminals, contents, and networks, 4K video services are being popularized. The year of 2017 witnessed the production of 80 million 4K TV sets globally. It is estimated that the number of global 4K video users will exceed 330 million by the year of 2020.

Many carriers around the world have taken video services as a strategic opportunity for ICT transformation. As 4K terminals are being popularized and content is getting rich, 4K services have gradually become a key means for carriers to develop differentiated competitiveness. For example, Deutsche Telekom (DT) believes that 4K video services make it possible to compete with pay-per-view TV services. British Telecom (BT) built the Next Generation Access (NGA) ultra-broadband network and released the BT Sport video services, achieving a service growth of 23%. China Telecom Sichuan has more than 5 million video users, among which 4K video users exceed 1.2 million and grow rapidly.

The requirement for watching 4K videos on multiple screens and anywhere makes Wi-Fi become the major method of carrying 4K video services on home networks in the future. Wi-Fi quality, however, has become the focus of user complaints. The main Wi-Fi quality issues are as follows: low rate, poor coverage, many interference sources, quality invisible to carriers, and difficulties in fault locating. These Wi-Fi issues adversely affect carriers' broadband brand, increase the percentage of invalid guarantees, and hinder the development of 4K video services.

According to a user video report from Conviva (a well-known company dedicated to online video optimization), when the video freezes, 1/3 of video users feel intolerable and immediately give up watching, and 84% of video users stop watching within 1 minute after the video experience deteriorates. Statistics indicate that nearly 1/3 of

users are not satisfied with the Wi-Fi coverage and rate at home, and 1/2 of users are willing to pay for Wi-Fi service packages. In this sense, better video experience based on Wi-Fi becomes the key to the commercial success of 4K video services.

In light of the home 4K over Wi-Fi network coverage and quality problems that telecom carriers and users are deeply concerned about, the carrier-grade home Wi-Fi networks need to use dual-band Wi-Fi home gateways as the cornerstone and fully utilize existing indoor cable resources or the 5G Wi-Fi frequency band as Wi-Fi extension media to implement intelligent Wi-Fi coverage. The gateways function as the control center to implement seamless Wi-Fi roaming and channel adjustment for the entire home network. In this way, optimal video experience can be provided, and home Wi-Fi networks can be managed, operated, and maintained. In addition, systematic key quality indicators (KQIs) and key performance indicators (KPIs) need to be provided on the experience of home 4K over Wi-Fi networks with home gateways as the cornerstone. By objectively quantifying end user experience (such as online 4K video latency), a solution is proposed to provide E2E optimal video experience, with manageable and maintainable home Wi-Fi network architecture. This solution helps carriers deploy high-quality home Wi-Fi networks in an efficient manner. It improves the quality of service (QoS) of 4K over Wi-Fi, Wi-Fi sensing, and cloud-based management and maintenance capabilities. This solution can effectively solve commercial-use problems such as poor home Wi-Fi coverage, low rate, and even fault locating difficulties.

On home Wi-Fi networks with optimal 4K video experience, home gateways function as the center, and Wi-Fi signals can be flexibly extended through various media such as Ethernet cables, power cables, wireless repeaters, and 5G Wi-Fi band, effectively solving home Wi-Fi coverage and performance problems. In addition, 1+N home networks deliver intelligent synchronization of network parameters, seamless roaming of terminals, Wi-Fi channel adjustment on the entire network, and QoS of 4K over Wi-Fi, achieving intelligent coverage and optimal video experience of home Wi-Fi networks. Self-service home Wi-Fi management is provided, facilitating maintenance and use. With a cloud management platform and mobile phone apps, home Wi-Fi networks can be quickly deployed, maintained, and managed, improving the operating efficiency of home Wi-Fi networks.

With the rapid development of 4K video services, the demand for watching videos on multiple screens and anywhere makes Wi-Fi the main method of carrying 4K video services at home. Carriers' focus is changed correspondingly from connection to experience, and home network construction methodology is also changed to service-driven and experience-driven. To provide users with good Wi-Fi coverage and optimal 4K video experience, home Wi-Fi networks centered on user experience need to be constructed. This document describes the technical principles, KQIs, and deployment suggestions for home Wi-Fi networks with optimal 4K video experience. Carriers can select appropriate deployment solutions based on network conditions and service development strategies.

# 02 4K Video Standards and Transmission Technology Requirements

## 2.1 4K Video Standards

### 2.1.1 4K Introduction

On August 23, 2012, ITU released ITU-R Recommendation BT.2020 (ultra-high-definition or UHD TV standards), indicating that 4K TV has entered the market. After over 5 years of development, 4K services are rich in terms of TV sets and programs. Users' requirements for 4K services at home have become standard requirements. In the tier-1 market, there are requirements for multiple channels of 4K services at home.

Video has been developed from HD to 4K.

Figure 2-1 Common video resolutions



Common video resolutions are SD (480p), HD (720p), full high definition or FHD (1080p), and UHD (4K). The 4K standard was initiatively established in the film industry and proposed as a TV standard by NHK Science & Technology Research Laboratories (STRL). It was adopted and defined by ITU. Consumer Electronics Association in the United States officially announced in October 2012 that 4K would be known as "Ultra High-Definition" or "Ultra HD" and used for screens that have an aspect ratio of 16:9 or wider and present native video at a minimum resolution of 3840 x 2160 pixels.

4K not only means a leap in video resolution, but also entails the following major improvements in video quality:

- Clearer images, thanks to the 3840 x 2160 resolution, which has 4 times as many pixels as FHD
- Smoother playback, with the frame rate increased from 24 fps (for HD) to 50 fps, 60 fps, or even 120 fps
- Truer colors, with the color depth increased from 8 bits to 10 or 12 bits
- More natural colors, because the color gamut of 4K videos is about 50% larger than that of HD videos and the bit rate of 4K video streams is usually over 4 times higher than that of FHD video streams with the same frame rate or compression scheme

4K video development goes through 3 phases, as described in Table 2-1. The frame rate and color depth used for carrier-grade 4K are the most suitable for current commercial deployment. As compression technologies reach maturity and keep being optimized, increase in the frame rate and color depth will not necessarily raise the bit rate required.

Table 2-1 Three phases of 4K video development

Phase	Quasi 4K	Carrier-grade 4K	Ultra 4K
Mature Time	2014–2015	2017–2018	2019 and afterwards
Resolution	3840 x 2160	3840 x 2160	3840 x 2160
Frame Rate	25 fps or 30 fps	50 fps or 60 fps	100 fps or 120 fps
Color Depth	8 bits	10 bits	12 bits
Compression Standard	HEVC, main profile	HEVC, main 10 profiles	HEVC, range extensions profiles
Compression Rate	Low	Medium	High
Average Bit Rate After Compression (Estimated)	VOD	12–16 Mbit/s	12–20 Mbit/s
	Live TV	25–30 Mbit/s	15–25 Mbit/s
			25–40 Mbit/s

The bit rates presented here are for reference only. Bit rates of media assets vary greatly with projects, from over 10 Mbit/s to 40 Mbit/s, depending on the media asset characteristics and compression technologies.

4K Video Standards and Transmission Technology Requirements

Table 2-1 describes the bandwidth requirements of 4K programs. With different frame rates and group of pictures (GOP) structures, the bit rate spans from 15 Mbit/s to 25 Mbit/s, and the resolution, frame rate, color depth, color gamut, and dynamic range continuously evolve. The resolution is developed from SD (480p) to HD (1280 x 720), FHD (1920 x 1080), UHD or 4K (3840 x 2160), and to 8K (7680 x 4320). The color depth is developed from 8 bits to 10 or 12 bits, and required bandwidths are getting increasingly high. Figure 2-2 shows the bandwidth evolution trend.

Figure 2-2 Commercial use trend of 4K videos

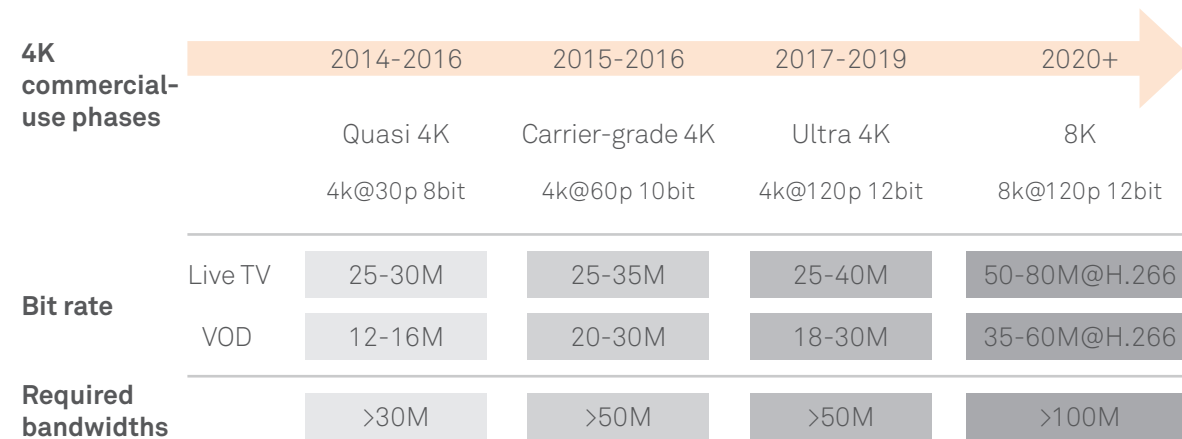

Based on this trend and the normal rate fluctuation in the variable bit rate (VBR) mode, the payload rate for 4K over Wi-Fi must be at least 50 Mbit/s, and in the future a single-channel payload bandwidth of 100 Mbit/s is required.

2.1.2 Common Video Technologies

Table 2-2 describes mainstream video technologies.

Table 2-2 Comparison of mainstream video technologies

Video Technology	Carrier	Comparison Description
Cable TV (CATV)	Traditional broadcast and television carriers	Although bidirectional interactive services are provided, the services are not open, interactive, or diversified enough. They are actually closed-end video services. Broadcast and television carriers have gradually penetrated into the IPTV field. In 2017, the number of CATV users in China was about 250 million (with fewer valid users as estimated) and was decreasing.
Direct to home (DTH) satellite video	Traditional broadcast and television carriers	
Digital terrestrial television (DTT)	Traditional broadcast and television carriers	
IPTV	Telecom carriers	IPTV is provided by telecom carriers on their IP private networks. It was initially developed as an additional bound service of broadband services and a substitute of traditional CATV. It will definitely be developed as a basic service of carriers, and evolved towards HD, intelligent, refined, multi-screen, and smart home services. In 2017, the number of IPTV users in China exceeds 120 million and was increasing.
HTTP streaming (OTT)	Internet enterprises	It is provided on the public Internet, with rich content and open platforms, which represents the development trend of video content services. The number of OTT devices reaches 240 million (188 million OTT devices are activated).

4K Video Standards and Transmission Technology Requirements

Carriers in this document mainly include telecom carriers (IPTV carriers and OTT carriers) and broadcast and TV carriers.

Table 2-3 compares the characteristics of IPTV and HTTP streaming (OTT) video services from the aspects of stream transmission protocols and network requirements.

Table 2-3 Characteristics comparison between IPTV and OTT video services

Item	IPTV	HTTP Streaming (OTT)
Video compression	MPEG4, H.264, H.265, and AVS2	MPEG4, H.264, and H.265
Encapsulation format	MPEG2-TS	MP4, RMVB, and MPEG2-TS
Stream transmission protocol	Real-Time Streaming Protocol (RTSP) or Real Time Protocol (RTP)	HTTP streaming transmission technologies, including HPD/HLS/HDS/HSS/DASH Encryption modes including HTTPS/SPDY/QUIC P2P also used in OTT scenarios as a supplement technology for HTTP streaming
Service quality	Authentic real-time streaming technologies achieve almost 0 latency and can play back videos from any time point. The service quality is high on carriers' private networks.	Progressive download, slicing, buffering, and playback undergo second-level buffering latency. The content can be played back only from the slice point of a streaming media file. Frame freezing may occur when the content comes from the Internet. The live TV effect is poor.
Network requirements	Multicast services are transmitted in UDP mode without the mechanism of retransmission upon packet loss, which is sensitive to packet loss on the network.	TCP is used. The TCP retransmission mechanism (UDP used for QUIC), multiple streams, and buffering technologies are used, which is sensitive to network latency.
Service functions	Multicast for live TV and unicast for VOD	Unicast used for both live TV and VOD, with a large amount of bandwidth occupied by live TV
Terminal type	Mainly for large-screen TV sets	For both large-screen TV sets and small-screen mobile phones
Service content	Advantageous to live TV programs, but for only a few other programs	Massive content, but with poor live TV experience

Summary:

1. Multicast services are mainly used in IPTV scenarios, and IPTV media streams are usually based on UDP. These services are sensitive to packet loss on the network. For VOD services, media streams are usually based on TCP, and the services are sensitive to latency.
2. HTTP streaming is mainly used in OTT video scenarios, based on TCP, and sensitive to latency. P2P is also used in OTT scenarios as a supplement technology for HTTP streaming. As development continues, HTTP streaming is also used by telecom carriers.
3. To solve problems with 4K over Wi-Fi in homes and meet requirements, problems of packet loss and latency on Wi-Fi links must be resolved.

### 2.1.3 Overview of 4K IPTV Streaming Transmission Protocols

There are 3 types of encoding frames in a 4K video encoding sequence: I, P, and B frames.

Figure 2-3 Encoding frames for 4K videos

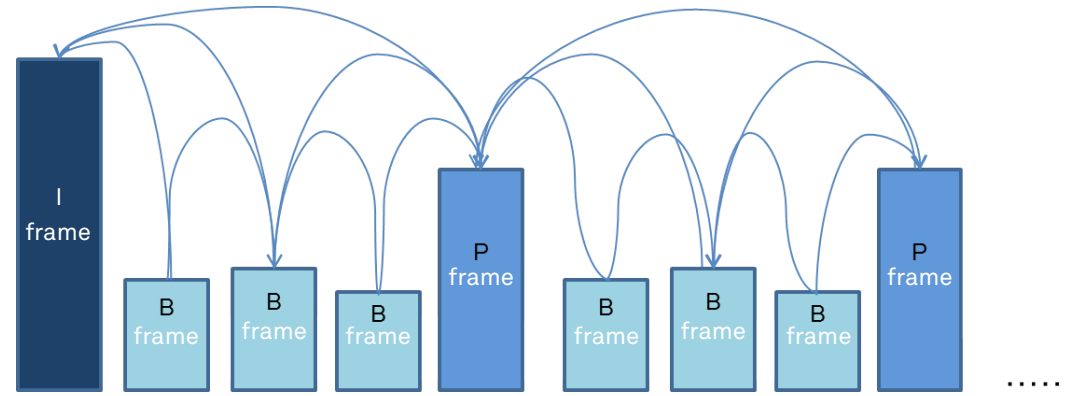

**I frame:** It is also known as the intra picture. The I frame is generally the first frame of each GOP structure (GOP is a video compression technology used by MPEG). After being properly compressed, it is used as a reference point for random access or as an image. During MPEG encoding, several video frame sequences are compressed into I frames, several into P frames, and several into B frames. The I-frame method is an intra-frame compression method, which is also called "key frame" compression method. The I-frame method is based on discrete cosine transform (DCT) which is similar to the JPEG compression algorithm. I-frame compression can achieve a compression ratio of 1/6 without obvious compression trace. If I frames are discarded, a black screen will occur.

**P frame:** In the process of encoding consecutive dynamic images, several consecutive images are divided into 3 types: P, B, and I frames. A P frame is predicted by its previous P frame or I frame. Information or data comparison is implemented between the current P frame and its previous P or I frame. That is, inter-frame compression is performed based on motion characteristics. The P-frame method is used to compress the data of the current frame according to the difference between the current frame and the previous I or P frame. This method of compression based on P and I frames together can achieve a higher compression ratio without any obvious compression trace. If P frames are discarded, video freeze will occur.

**B frame:** The B-frame method uses an inter-frame compression algorithm based on bidirectional prediction. When a frame is compressed into a B frame, compression is based on the difference between the previous frame, the current frame, and the next frame. That is, only the difference between the current frame and the previous/next frame is recorded. The maximum compression ratio can reach 200:1. If a reference B frame is discarded, video freeze and artifacts will occur. If a non-reference B frame is discarded, no frame freeze or artifact occurs.

RFC 2250 standards (RTP Payload Format for MPEG1/MPEG2 Video) stipulate that I, B, and P frames in MPEG video streams can be directly encapsulated into RTP packets. An MPEG video specific header is added to the RTP header, as shown in Figure 2-4.

Figure 2-4 Structure of the MPEG video specific header

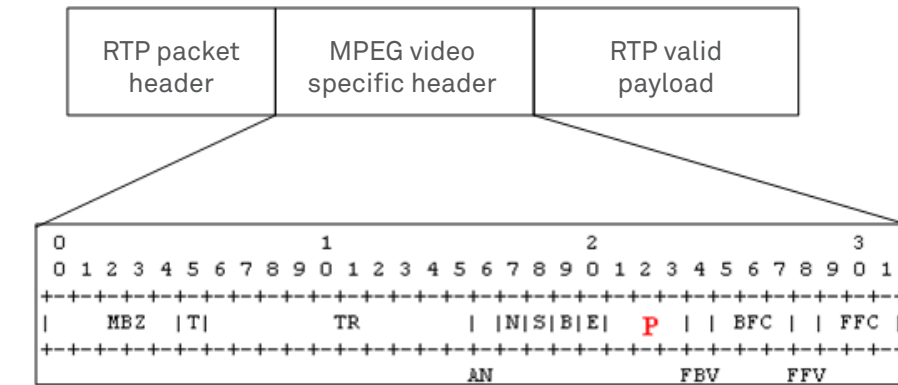

An MPEG video specific header contains 4 bytes, among which the P field occupies 3 bits. The P field indicates the packet type. Its values are as follows:

- 1: I frame
- 2: P frame
- 3: B frame
- 4: D
- 0: prohibited value
- Other values: reserved

MPEG over TS videos use a similar frame format. The I, B, and P frames are split into single TS streams and then sent out in packets.

## 2.2 4K Transmission Technology Requirements

### 2.2.1 Service Performance KPIs

"100M anywhere" home networks must address the requirements of at least two 4K TV (30p) services and 100M continuous coverage.

Table 2-4 4K TV (30p) service requirements for home Wi-Fi bandwidth, latency, and packet loss rate

Parameter	1080p	Quasi 4K	Basic 4K	True 4K	Ultra 4K
Resolution	1920 x 1080	3840 x 2160	3840 x 2160	3840 x 2160	3840 x 2160
Frame rate	23p	23p	30p	50/60p	100/120p
Sampled bits	8	8	8	10	12
Compression	H.264	H.264/H.265	H.265	H.265	H.265
Bandwidth requirement	5-8 Mbit/s	8-15 Mbit/s	20-30 Mbit/s	30-50 Mbit/s	50-100 Mbit/s
Latency	12-20 ms	7-12 ms	6-11 ms	6-11 ms	6-11 ms
Packet loss rate	5*10 <sup>-4</sup>	5*10 <sup>-4</sup>	1*10 <sup>-4</sup>	5*10 <sup>-5</sup>	5*10 <sup>-5</sup>



For the next generation home networks, to achieve 100M continuous coverage, the Wi-Fi throughput in major Internet access positions in typical home environments is also required to reach 100 Mbit/s.

Different video programs have the following major requirements on the transmission network: bandwidth, latency, and packet loss rate. For carrier-grade 4K, a bit rate of 30–50 Mbit/s is used for constant bit rate (CBR) IPTV programs. To ensure stable transmission of 4K IPTV, the transmission network must have a packet loss rate less than  $5 \times 10^{-5}$ .

Due to the instability, interference from adjacent APs, large rate fluctuation, and unexpected packet loss of Wi-Fi links, it is difficult for the packet loss rate of 4K over Wi-Fi to reach less than  $5 \times 10^{-5}$ . In practice, the packet loss rate on the Wi-Fi air interface is at the  $10^{-2}$  to  $10^{-3}$  level. To support 4K over Wi-Fi based on actual Wi-Fi situations, it is required that no video freeze occurs for 4K video transmission in a home scenario with the unexpected Wi-Fi packet loss rate in the range of  $10^{-2}$  to  $10^{-3}$ .

### 2.2.2 Service Experience KQIs

#### KQIs of HTTP Streaming (OTT) Video Service Experience

The following describes the KQIs of online VOD through Wi-Fi.

KQIs of online video experience perceived by users are as follows: first buffering time, number of freeze times, and freeze rate. The details are as follows:

- **First buffering time:** When a user initiates video program ordering or performs a fast-forward or rewind operation (the target playback time is the time when buffering is not performed) during video display, a terminal sends requests to obtain the OTT program source until the data sent back by the OTT cloud platform meets the requirement and the first video image of the terminal is displayed. The first buffering time refers to the wait time between the terminal sending the requests and the terminal displaying the first video image.
- **Number of freeze times:** Within the specified watching time (5 minutes for example), if the data download volume is less than the data volume required for video decoding and playback, video freeze occurs and the user needs to wait until buffering is completed. The number of freeze times does not include the number of pauses initiated by the user or the number of pauses upon heavy CPU load of the terminal.
- **Freeze rate:** Within the specified watching time (5 minutes for example), if the data download volume is less than the data volume required for video decoding and playback, video freeze occurs and the user needs to wait until buffering is completed. The number of freeze times does not include the number of pauses initiated by the user or the number of pauses upon heavy CPU load of the terminal. The freeze ratio refers to the ratio of the total buffering time to the specified watching time.

Table 2-5 KQIs of video service experience

Experience Level	MOS	KQIs		
		First Buffering Time (ms)	Video Freeze Times	Freeze Rate
Excellent	5	≤100	0	0%
Good	4	1000	1	0.1%
Fair	3	2000	3	1%
Poor	2	5000	6	5%
Bad	1	8000	>10	10%

#### KQIs of IPTV Video Service Experience

Table 2-6 lists KQIs that affect overall video experience.

Table 2-6 IPTV Video Service Experience KQI

Video Development Stage			Developing		High quality		
Mainstream Video Resolution			720p and lower	1080p	4K		
VOD	Typical Bit Rate		2M	5M	15M		
	KQIs	U-vMOS.s View = 5	Bandwidth	≥ 6.4 Mbit/s	≥ 15 Mbit/s	≥ 22.5 Mbit/s	
			RTT	≤ 30 ms	≤ 20 ms	≤ 20 ms	≤ 10 ms
			PLR	≤ $3.5 \times 10^{-3}$	≤ $1.5 \times 10^{-3}$	≤ $3 \times 10^{-4}$	≤ $1 \times 10^{-3}$
	KQIs	U-vMOS.s Interaction = 4	Bandwidth	≥ 8 Mbit/s	≥ 20 Mbit/s	≥ 50 Mbit/s	
			RTT	≤ 30 ms	≤ 20 ms	≤ 20 ms	≤ 10 ms
			PLR	≤ $2 \times 10^{-3}$	≤ $8 \times 10^{-4}$	≤ $1 \times 10^{-4}$	≤ $5 \times 10^{-4}$
	Live TV	Typical Bit Rate		2M	8M	20M	
KQIs		U-vMOS.s Interaction = 4	Bandwidth	≥ 4.6 Mbit/s (if RTT ≤ 20 ms)	≥ 14 Mbit/s (if RTT ≤ 20 ms)	≥ 36 Mbit/s (if RTT ≤ 20 ms)	
			RTT	Time from the multicast terminal to the last multicast replication point ≤ 20 ms (recommended, not mandatory)			
			Jitter	Maximum jitter ≤ 50 ms Average jitter ≤ 5 ms (Gaussian distribution)			
KQIs		U-vMOS.s View = 4	PLR	≤ $1 \times 10^{-5}$ (RET not applied)			
			RTT	Time from the multicast terminal to the last multicast replication point ≤ 20 ms (recommended, not mandatory)			
			Jitter	Maximum jitter ≤ 50 ms Average jitter ≤ 5 ms (Gaussian distribution)			
KQIs		U-vMOS.s View = 5	PLR	= 0 (RET not applied) ≤ $1 \times 10^{-4}$ (RET applied)			

For either HTTP streaming or 4K IPTV, what users can directly sense includes black screen, frame freeze, and artifacts. The following chapters focus on how to solve issues in experience of 4K over Wi-Fi, and how to solve the black screen, frame freeze, and artifacts in most scenarios of 4K over Wi-Fi.

# 03 Challenges of 4K over Wi-Fi

## 3.1 4K Video Bit Rate

The amount of information that needs to be carried in a unit of time varies according to the content of a video. When video streams are transmitted over a network, the bit rate changes dynamically and the network bandwidth requirements change accordingly.

Figure 3-1 Video bit rate change

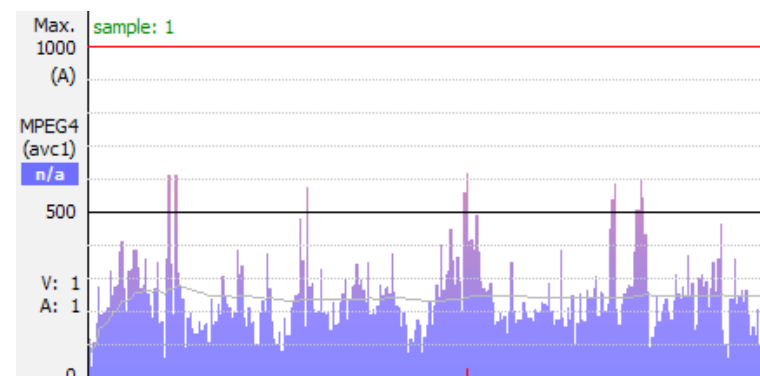

4K videos are available in 2 bit rate modes: CBR and VBR.

## 3.2 4K Live TV Principles

### 3.2.1 4K Live TV Playback Principle

Figure 3-2 shows the 4K live TV playback principle.

Figure 3-2 4K live TV playback principle

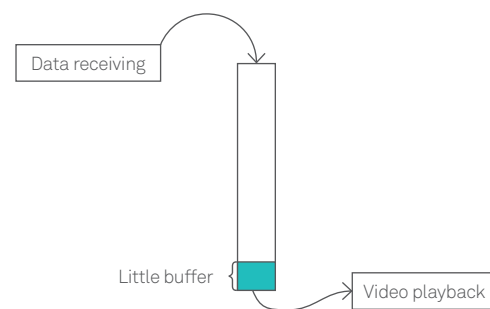

To reduce the channel change latency and start playback upon data receiving, the initial buffer of a set-top box (STB) is little.

### 3.2.2 Causes of Frame Freeze During 4K IPTV Live Playback

4K live TV uses UDP for transmission. There is no confirmation mechanism. If packet loss occurs occasionally on the network, artifacts appear on the screen during the display of the video.

If the equivalent rate of the Wi-Fi physical air interface is lower than the average video bit rate, not all video streams can be transmitted, resulting in frame freeze. A higher bit rate of 4K videos has a higher requirement for the equivalent rate of the Wi-Fi physical air interface.

If the equivalent rate of the Wi-Fi physical air interface is not lower than the average video bit rate but is lower than the real-time video bit rate in a specific period, or the Wi-Fi transmit latency is large and packets are not sent in time, the STB buffer is exhausted and frame freeze occurs. Frame freeze for the first time will cause a buffer increase, and therefore the possibility that the frame freeze occurs again is decreased. If the channel is switched, the original buffered packets are discarded and the buffer is restored to the initial state.

Figure 3-3 Causes of frame freeze during 4K live TV playback

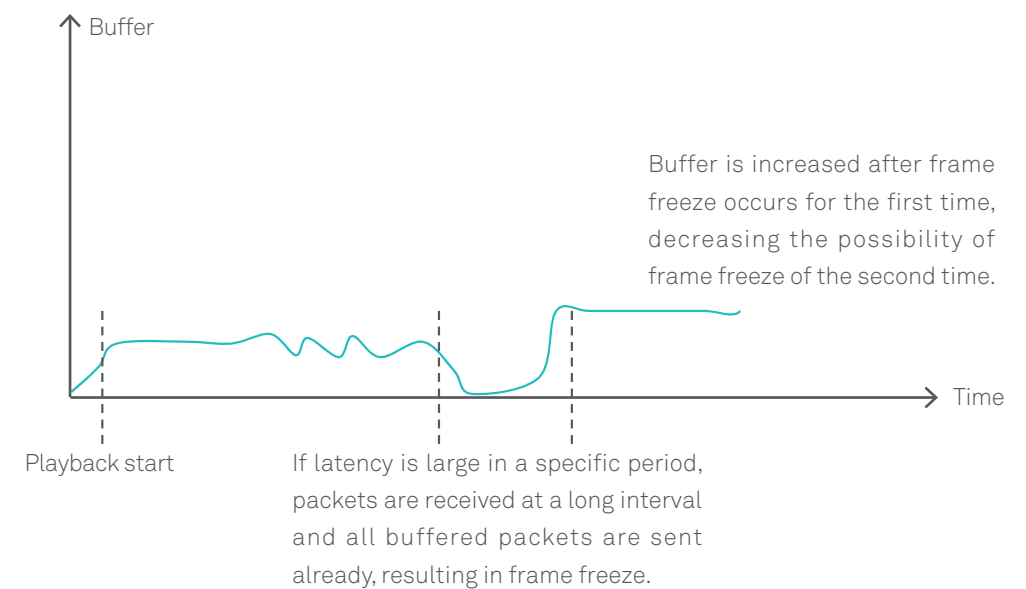



### 3.3 4K VOD Principle

#### 3.3.1 4K VOD Playback Principle

Figure 3-4 shows the 4K VOD playback principle.

Figure 3-4 4K VOD playback principle

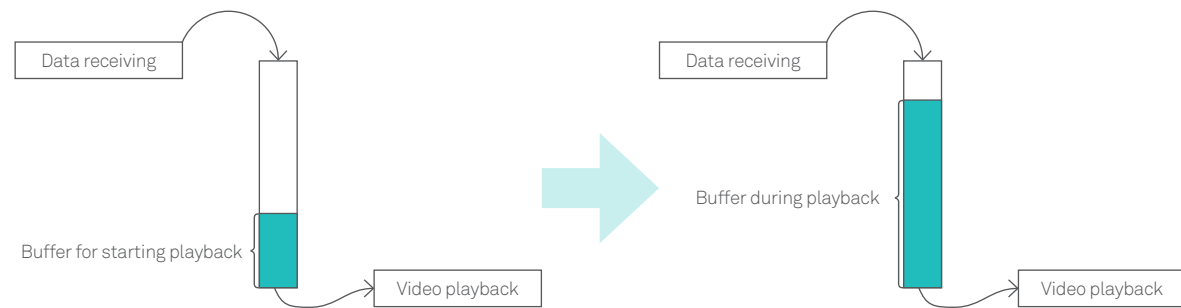

Unlike 4K live TV, data of a specific volume can be buffered before 4K VOD playback. The initial buffering time of VOD is much longer than the channel switching of live TV. After the playback starts, more data can be buffered during playback to better withstand network jitter.

#### 3.3.2 Causes of Frame Freeze During 4K VOD Playback

4K VOD uses TCP for transmission. There is a confirmation mechanism. Packet loss does not cause frame freeze. If packet loss occurs on the network, the TCP sliding window decreases and the transmission rate decreases. If the transmission rate is lower than the 4K video bit rate for a long period, the STB buffer is exhausted and frame freeze occurs.

If the Wi-Fi equivalent rate is lower than the average video bit rate, not all video streams can be transmitted, resulting in frame freeze. A higher bit rate of 4K videos has a higher requirement for the Wi-Fi equivalent rate.

If the Wi-Fi equivalent rate is not lower than 1.5 times of the average video bit rate but is lower than the real-time video bit rate in a specific period, or the Wi-Fi transmit latency is long and packets are not sent in time, the STB has buffered data and no video freeze occurs.

Figure 3-5 Causes of frame freeze during 4K VOD playback

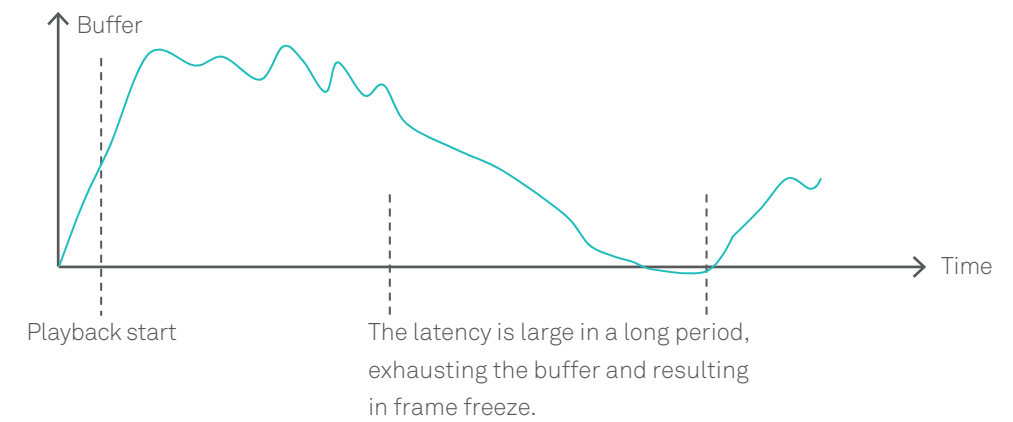
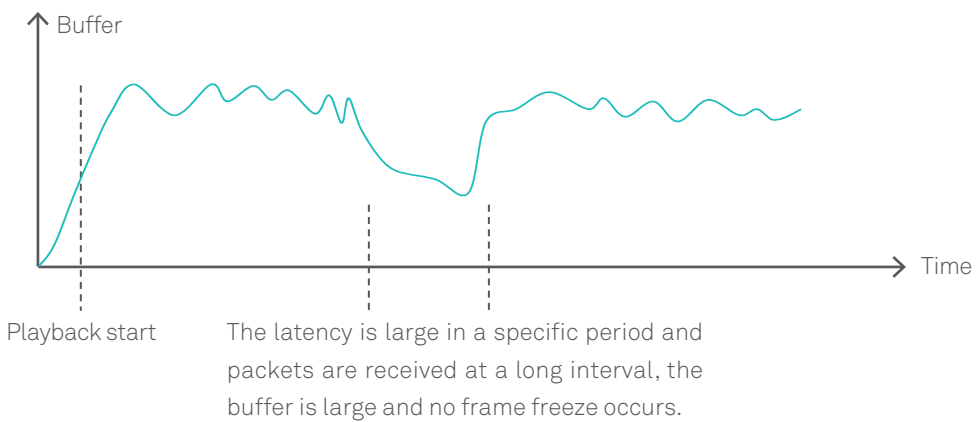

If the network latency is long, the RTT time is increased. The TCP sliding window decreases and the transmission rate also decreases. If the transmission rate is lower than the 4K video bit rate for a long period, the STB buffer is exhausted and frame freeze occurs.

### 3.4 Wi-Fi Transmission Principles

#### 3.4.1 Wi-Fi Equivalent Rate

Figure 3-6 shows the Wi-Fi equivalent rate.

Figure 3-6 Wi-Fi equivalent rate

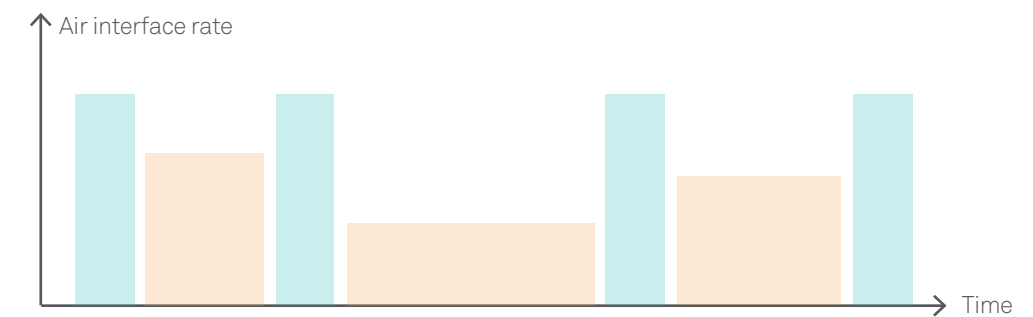

In the time indicated by a green box in Figure 3-6, the current Wi-Fi device sends 4K video packets. In the time indicated by a pink box, the current Wi-Fi device sends other packets or another Wi-Fi device sends packets. The height of a box indicates the air interface rate, and the width indicates the transmission time. The sum of the areas of green boxes divided by the total time is the equivalent rate of sending 4K videos by the Wi-Fi device.

Two factors affect the Wi-Fi equivalent rate: interference duty cycle (the rate of time occupied by pink boxes) and air interface rate. By selecting channels with less interference, the interference duty cycle can be decreased and the rate of time occupied by green boxes can be increased.

Table 3-1 describes air interface rates by using IEEE 802.11ac specifications and 80 MHz channel bandwidth as an example.

Challenges of 4K over Wi-Fi

Table 3-1 Air interface rates (IEEE 802.11ac, 80 MHz channel bandwidth)

MCS Index	Spatial Streams	Modulation Scheme	Coding Rate	Air Interface Rate (Mbit/s)
0	1	BPSK	1/2	32.5
1	1	QPSK	1/2	65.0
2	1	QPSK	3/4	97.5
3	1	16-QAM	1/2	130.0
4	1	16-QAM	3/4	195.0
5	1	64-QAM	2/3	260.0
6	1	64-QAM	3/4	292.5
7	1	64-QAM	5/6	325.0
8	1	256-QAM	3/4	390.0
9	1	256-QAM	5/6	433.3
0	2	BPSK	1/2	65.0
1	2	QPSK	1/2	130.0
2	2	QPSK	3/4	195.0
3	2	16-QAM	1/2	260.0
4	2	16-QAM	3/4	390.0
5	2	64-QAM	2/3	520.0
6	2	64-QAM	3/4	585.0
7	2	64-QAM	5/6	650.0
8	2	256-QAM	3/4	780.0
9	2	256-QAM	5/6	866.7
0	3	BPSK	1/2	97.5
1	3	QPSK	1/2	195.0
2	3	QPSK	3/4	292.5
3	3	16-QAM	1/2	390.0
4	3	16-QAM	3/4	585.0
5	3	64-QAM	2/3	780.0
6	3	64-QAM	3/4	877.5
7	3	64-QAM	5/6	975.0
8	3	256-QAM	3/4	1170.0
9	3	256-QAM	5/6	1300.0
0	4	BPSK	1/2	130.0
1	4	QPSK	1/2	260.0
2	4	QPSK	3/4	390.0
3	4	16-QAM	1/2	520.0
4	4	16-QAM	3/4	780.0
5	4	64-QAM	2/3	1040.0
6	4	64-QAM	3/4	1170.0
7	4	64-QAM	5/6	1300.0
8	4	256-QAM	3/4	1560.0
9	4	256-QAM	5/6	1733.3

Challenges of 4K over Wi-Fi

More spatial streams mean a higher air interface rate. The number of spatial streams is the smaller value between the number of spatial streams supported by an AP and the number of spatial streams supported by a station (STA). Higher specifications of spatial streams supported by an AP or STA can better transmit 4K videos.

A higher modulation scheme and a higher coding rate mean a higher air interface rate. The modulation scheme and coding rate depend on the signal strength and noise strength. In 802.11ac, different modulation schemes and coding rates have different signal strength requirements.

Table 3-2 Signal strength requirements in 802.11ac

Table 22-25—Receiver minimum input level sensitivity

Modulation	Rate ( R )	Minimum sensitivity (20MHz PPDU )( dBm )	Minimum sensitivity (40MHz PPDU )( dBm )	Minimum sensitivity (80MHz PPDU )( dBm )	Minimum sensitivity (160MHz or 80+80 MHz PPDU )( dBm )
BPSK	1/2	-82	-79	-76	-73
QPSK	1/2	-79	-76	-73	-70
QPSK	3/4	-77	-74	-71	-68
16-QAM	1/2	-74	-71	-68	-65
16-QAM	3/4	-70	-67	-64	-61
64-QAM	2/3	-66	-63	-60	-57
64-QAM	3/4	-65	-62	-59	-56
64-QAM	5/6	-64	-61	-58	-55
256-QAM	3/4	-59	-56	-53	-50
256-QAM	5/6	-57	-54	-51	-48

The following table describes the signal-to-noise ratio requirements of different modulation schemes and coding rates for 802.11ac.

Table 22-24—Allowed relative constellation error versus constellation size and coding rate

Modulation	Coding rate	Relative constellation error ( dB )
BPSK	1/2	-5
QPSK	1/2	-10
QPSK	3/4	-13
16-QAM	1/2	-16
16-QAM	3/4	-19
64-QAM	2/3	-22
64-QAM	3/4	-25
64-QAM	5/6	-27
256-QAM	3/4	-30
256-QAM	5/6	-32

Challenges of 4K over Wi-Fi

By adjusting the device placement and antenna angle of an external antenna device, the signal strength and the air interface rate can be increased. By selecting a channel with a low noise floor ratio, the signal-to-noise ratio and the air interface rate can be increased.

3.4.2 Wi-Fi Transmission Latency

There may be multiple Wi-Fi devices on the air interface. Therefore, Wi-Fi devices cannot directly send data but need to compete for the air interface.

Figure 3-7 Wi-Fi air interface competition mechanism

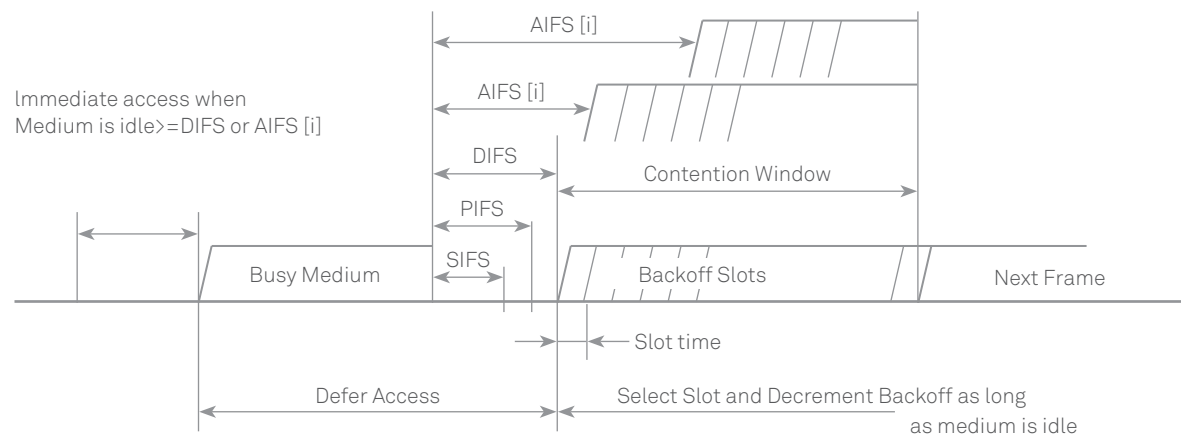

If there are a small number of Wi-Fi devices on the air interface, it is easy to compete for the transmission opportunity. Therefore, the Wi-Fi transmission latency is small.

Figure 3-8 Air interface competition when there are a few Wi-Fi devices

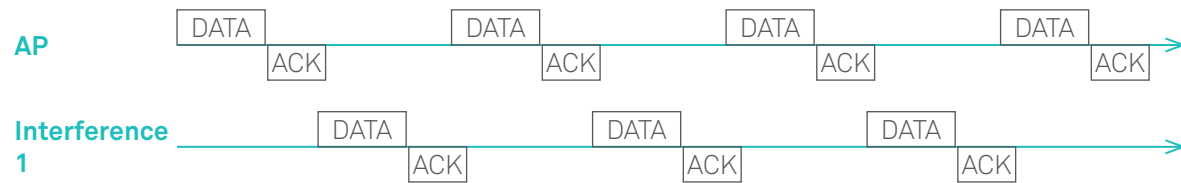

If there are a large number of Wi-Fi devices on the air interface, it takes a long time to compete for the transmission opportunity. As a result, the Wi-Fi transmission latency is large.

Figure 3-9 Air interface competition when there are many Wi-Fi devices

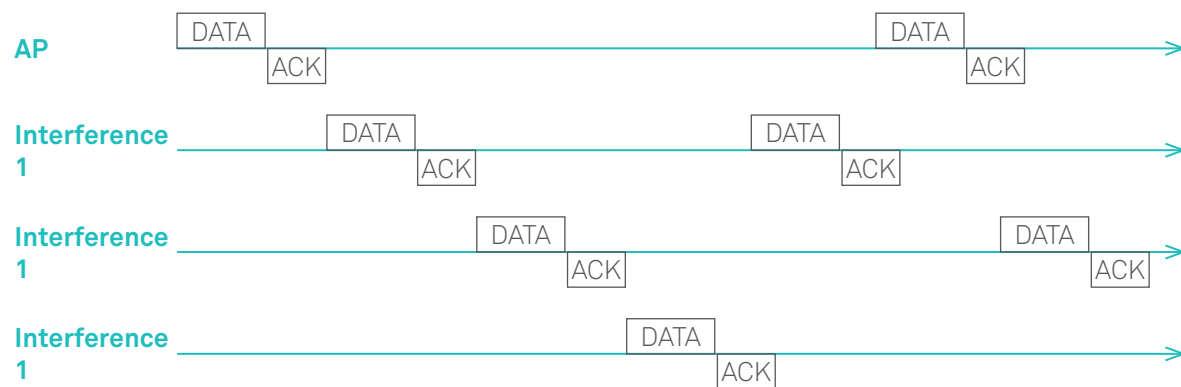

Challenges of 4K over Wi-Fi

If multiple users are connected to a Wi-Fi device, the Wi-Fi device needs to send packets of different users in turn. This increases the queuing latency for a single user.

3.4.3 Wi-Fi Packet Loss

The Wi-Fi device implements a retransmission acknowledgment mechanism. If the device does not receive an ACK message from the peer device, it retransmits packets. If the air interface conflict is severe in a specific period and there is a conflict each time packets are to be sent, the Wi-Fi device discards the packets after the number of retransmission times reaches a specific value. As a result, packet loss occurs.

Figure 3-10 Wi-Fi packet loss

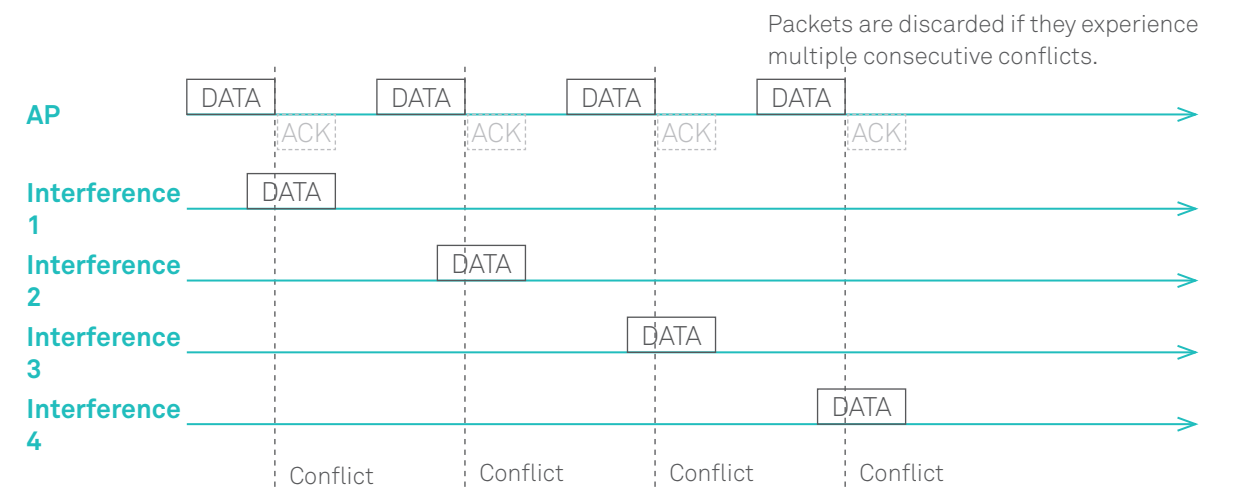

If the air interface is busy for a period and the Wi-Fi device does not have an opportunity to send packets, packets are discarded due to air interface timeout. As a result, packet loss occurs.

Figure 3-11 Wi-Fi packet loss

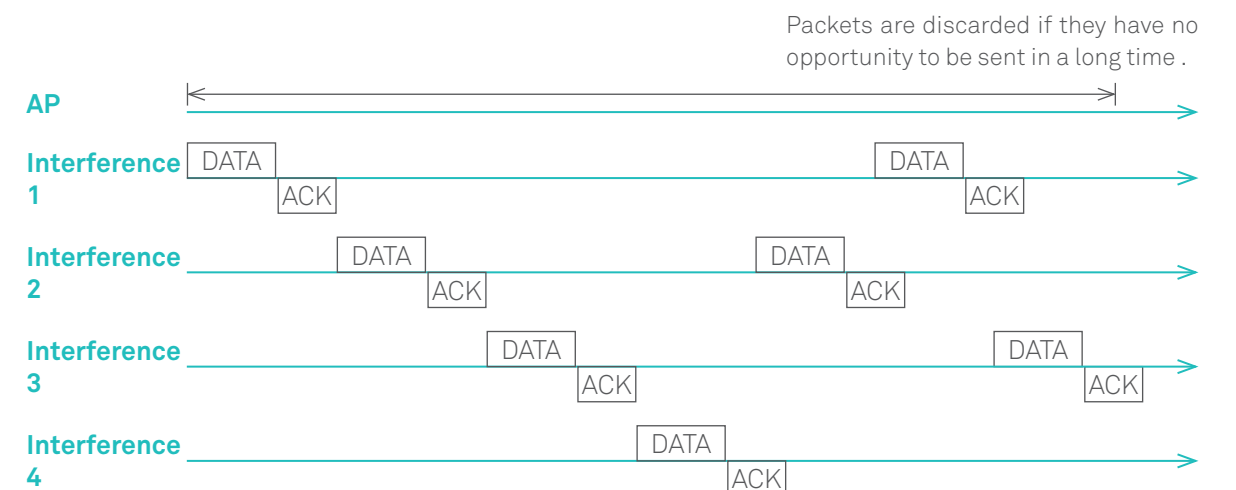

If the Wi-Fi equivalent rate is insufficient and is lower than the video bit rate within a specific period, the packet queue of the Wi-Fi device keeps increasing and finally overflows. As a result, packet loss occurs.



Figure 3-12 Wi-Fi packet loss

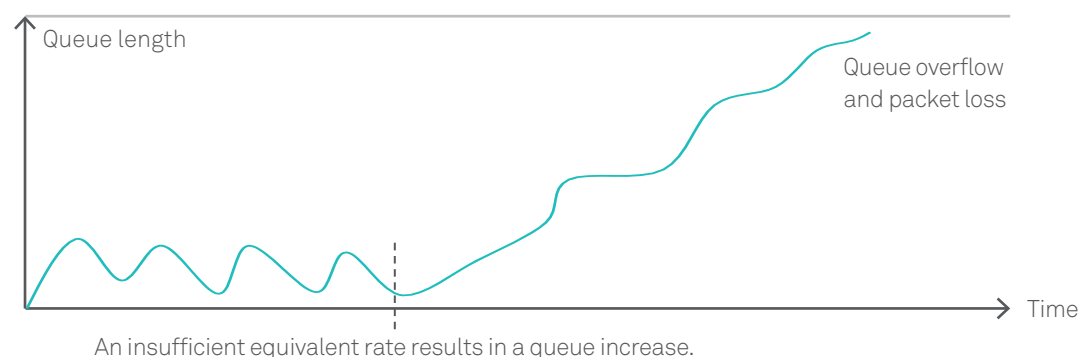

### 3.5 Challenges of 4K over Wi-Fi

#### 3.5.1 Signal Attenuation

Wi-Fi signal attenuation mainly comes from 2 aspects: free space attenuation and obstacle attenuation.

Table 3-3 lists the free space attenuation.

Table 3-3 Free space attenuation of Wi-Fi signals

Distance (m)	Operating Frequency (GHz)	Space Attenuation (dB)
1	5.8	47.7
2	5.8	53.7
3	5.8	57.2
4	5.8	59.7
5	5.8	61.6
6	5.8	63.2
7	5.8	64.6
8	5.8	65.7
9	5.8	66.8
10	5.8	67.7

Table 3-4 lists the typical obstacle attenuation.

Table 3-4 Typical obstacle attenuation of Wi-Fi signals

WiFi attenuation in different substance

Modulation	Ref Attenuation ( dB )	
	2.4GHz	5.8GHz
Space Atten @ 5m	54	62
Space Atten @ 10m	60	68

Space Atten @ 15m	64	71
Wood Door	3	4
Glass Window	4	7
Thick Glass	8	10
12cm Brick Wall	10	20
24cm Brick Wall	15	25
Concrete Iron Wall	25	30

Table 3-4 lists the attenuation when Wi-Fi signals vertically traverse obstacles. The attenuation is higher if Wi-Fi signals obliquely traverse obstacles.

The transmit power of a Wi-Fi device is generally 23–30 dBm. If the distance is 5 m and signals vertically penetrate through a concrete wall, the attenuation is 92 dB (62 + 30), the signal strength is -69 dBm to -62 dBm, and the corresponding MCS index value is 2–4. For a device with 2 spatial streams, the air interface rate is 190–390 Mbit/s. If the distance is longer or Wi-Fi signals penetrate through a wall obliquely, the attenuation is larger and the air interface rate is lower. If Wi-Fi signals penetrate a brick wall, the attenuation is small and the air interface rate is high.

The attenuation values and attainable air interface rates depend on the actual deployment environments. The deployment environments of Wi-Fi devices are a challenge for 4K over Wi-Fi.

#### 3.5.2 Interference Duty Cycle and Noise Floor

A high air interface rate does not necessarily mean that 4K videos can be transmitted. Interference needs to be also considered.

Wi-Fi devices using the same channel or nearby the current Wi-Fi devices affect the interference duty cycle. A larger number of such Wi-Fi devices or a higher traffic volume causes a larger interference duty cycle.

If there are Wi-Fi devices at different channels or far away from the current Wi-Fi device, or there are non-Wi-Fi devices within the Wi-Fi frequency range, noise floor is generated, which affects the signal-to-noise ratio.

The number of Wi-Fi devices with interference and the interference duration depend on the neighboring device deployment and usage. For a family, the surrounding interference is uncontrollable, and therefore the Wi-Fi equivalent rate is uncontrollable. The interference around Wi-Fi devices is another challenge for 4K over Wi-Fi.

#### 3.5.3 Multi-STA Access and Service Concurrency

When multiple STAs are concurrently connected, there is a burst of services such as BitTorrent downloading, file downloading, and video service streams. It is a challenge to ensure the scheduling priority of video services.

A home low-speed STA adversely affects the performance of the entire air interface, which further affects video over Wi-Fi.

# 04

## Key Features of 4K over Wi-Fi

Home gateways are the cornerstone for building home networks with best video experience. Wi-Fi signals can be flexibly extended through various media such as Ethernet cables, power cables, wireless repeaters, and 5G Wi-Fi, effectively solving home Wi-Fi coverage and performance problems. In addition, 1+N home networks deliver key features such as intelligent synchronization of network parameters, seamless roaming of terminals, Wi-Fi channel adjustment on the entire network, and QoS of 4K over Wi-Fi, achieving intelligent coverage and optimal video experience of home Wi-Fi networks.

### 4.1 Specifications Requirements on Home Gateways and APs

The hardware configurations and specifications of gateways and APs are critical to the performance and quality of home networks. For example, the CPU, memory, flash, and Wi-Fi specifications have great impact on the forwarding performance and Wi-Fi throughput. Lightning protection and energy conservation are important for security and stability, and smart gateways can support future smart home services. Table 4-1 describes the specifications requirements on home gateways and APs.

Table 4-1 Specifications of home gateways and APs

Item	Home Gateway Specifications	AP Specifications
Memory	256 MB or more	128 MB or more
Flash	256 MB or more	128 MB or more
Wi-Fi specifications	Higher than 2 x 2 11ac + 2 x 2 11n	Higher than 2 x 2 11ac + 2 x 2 11n
NNI	GPON/XG-PON/10G EPON/1GE	1GE/5G Wi-Fi/PLC
UNI	2/4 x GE+2.4G Wi-Fi+5G Wi-Fi	1 x GE+2.4G Wi-Fi+5G Wi-Fi
Antenna gain	Higher than 2 dBi	Higher than 2 dBi
Wi-Fi channel adjustment	Automatic adjustment	Automatic channel adjustment, and channel adjustment controlled by smart gateways
Proactive Wi-Fi roaming	STA roaming based on 802.11k or 802.11v Roaming decision center	STA roaming based on 802.11k or 802.11v
Video transmission	Video packet priority marking, and support for Wi-Fi Multimedia (WMM)	Support for WMM

Band steering	5G with preference over 2.4G	5G with preference over 2.4G
Beamforming	Beamforming and directive sending	Beamforming and directive sending
Service provisioning	Existing provisioning modes of carriers	Plug-and-play without need of configuration
Intelligent operating system	Open Services Gateway Initiative (OSGi)	N/A
Remote management and maintenance	Home network management based on plug-ins	Management by smart gateways
Energy conservation	Wi-Fi energy conservation mode	Wi-Fi energy conservation mode
Lightning protection	4 kV	4 kV
CE certification	Required	Required
Wi-Fi Alliance certification	Required	Required

### 4.2 Performance Improvement of Home Wi-Fi Networks

#### 4.2.1 Intelligent Channel Management

Only 3 unique channels are available on the 2.4G frequency band, and all APs must select among the 3 channels. Physically neighboring APs, however, must use different channels. Although there are many 5G channels, the channel-and-power relationship of neighboring APs must be properly processed. When intelligent channel management is not available, a user needs to manually configure the channel and power of each AP. The configuration process is complex. In addition, after the environment changes, the configured channel and power of an AP may no longer meet the requirements. To simplify the configuration process, a global function of intelligent channel and power adjustment is important.

Figure 4-1 Periodic and automatic Wi-Fi optimization

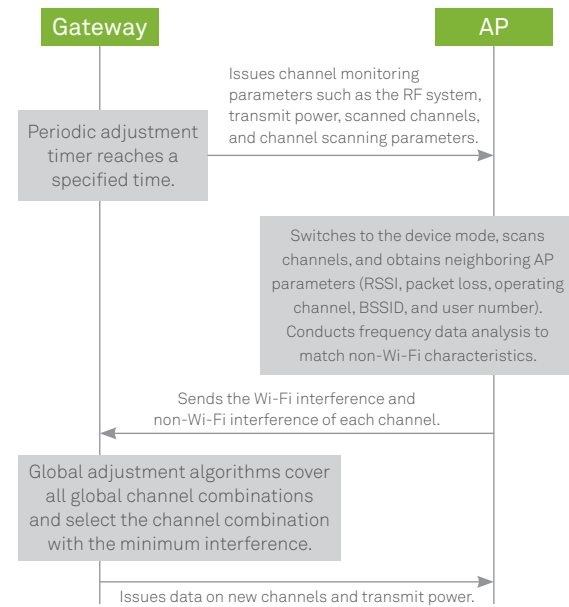
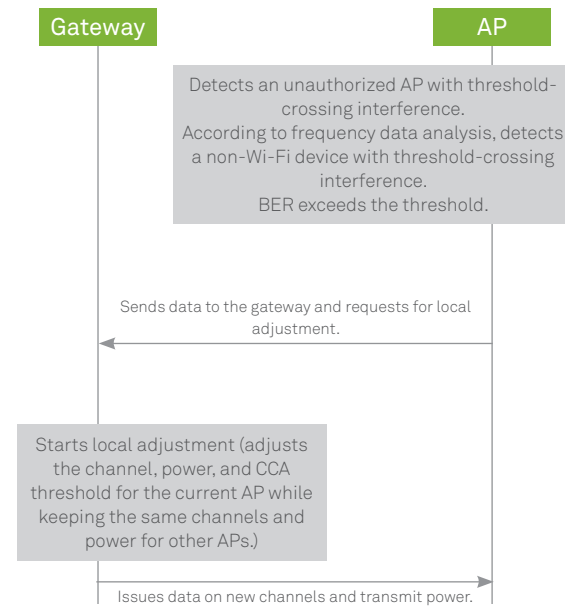
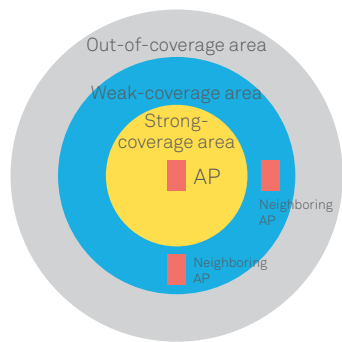

Figure 4-2 Event-triggered Wi-Fi optimization



The purpose of intelligent power management is to ensure a balance between the maximum coverage and minimum interference with the external. A strong-coverage area and a weak-coverage area need to be defined based on the room layout and services. For example, in 2.4G channels, an area with signal strength over -70 dbm is defined as the strong-coverage area, and an area with signal strength in range of -90 dbm to -70 dbm is defined as the weak-coverage area. The strong-coverage area must cover the major terminal service points of an AP. If a neighboring AP is out of the coverage area, the coverage may be insufficient. Deploy as many neighboring APs as possible in the weak-coverage area to ensure overlapping coverage to a specific degree. Do not install neighboring APs in the strong-coverage area. Otherwise, it is difficult to allocate channels without any conflict. If required, increase or decrease the coverage areas by adjusting the transmit power of an AP.

Figure 4-3 Intelligent power management



For example, when a distributed AP is added, the transmit power of the gateway and other APs can be decreased to prevent unnecessary external interference. When a distributed AP is faulty, the transmit power of the gateway and other APs can be increased to enhance the coverage.

Larger data traffic volume and higher transmit power cause greater interference to the external. Therefore, if the performance meets the requirements with a low traffic and bit error rate (BER), the transmit power can be decreased appropriately. When the data traffic increases or the BER increases, the transmit power needs to be increased appropriately.

A gateway or AP can perform per-packet power control. A gateway and an AP detect the signal strength of each terminal in real time. If the signal strength of a terminal (near the AP) is stronger than the power control target value, the actual transmit power is decreased when a packet is sent to the terminal. If the signal strength of a terminal (far from the AP) is less than the target value, the transmit power is increased when a packet is sent.

### 4.2.2 Dynamic Anti-Interference

In a dense high-rise residential environment, it is difficult to find an idle channel. When an AP has to use a congested channel, dynamic adjustment based on clear channel assessment (CCA) can be used to improve the interference tolerance of the system. An AP or terminal determines whether a channel is idle by performing energy detection on the channel.

Figure 4-4 CCA assessment

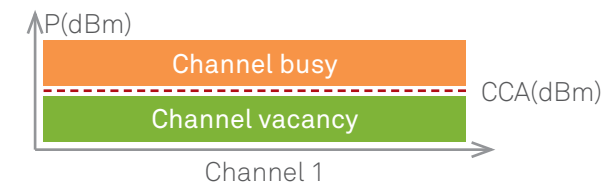

The description is as follows:

- When the energy of a channel is greater than or equal to the CCA threshold, the channel is considered busy and signals are not transmitted over this channel.
- When the energy of a channel is smaller than the CCA threshold, the channel is considered idle and signals are transmitted over this channel.

In a dense high-rise residential environment, because of high density and short distance of APs and terminals, the signal strength is stronger than that in a common scenario. The energy detected on a channel is prone to exceed the CCA threshold. As a result, the APs or terminals cannot send data. The CCA optimization feature can dynamically adjust the CCA threshold based on the wireless channel interference, BER, and service requirements. When the BER for a terminal meets the requirement and the terminal has a higher priority, the CCA threshold can be increased appropriately to obtain more transmission opportunities.

### 4.2.3 Intelligent Terminal Guidance

Band steering: When a terminal supports 2 frequency bands (2.4G and 5G), the gateway or AP directs the terminal to a proper frequency band according to the congestion status of the 2 frequency bands, the service characteristics of the terminal, and the received signal strength indicator (RSSI) strength of the 2 frequency bands of the terminal.

Figure 4-5 Working principle of band steering

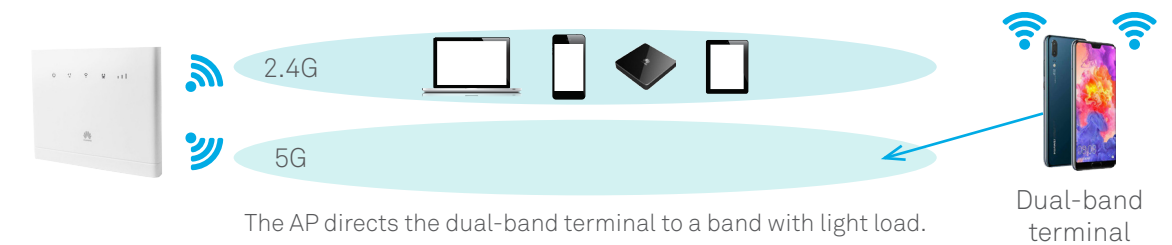

Service set identifier (SSID) steering: When a terminal can connect to multiple SSIDs, the gateway or AP directs the terminal to the most suitable SSID based on the congestion status of each SSID for the purpose of load balancing.



Key Features of 4K over Wi-Fi

Figure 4-6 Working principle of SSID steering



AP steering: Each AP periodically scans channel information and finds a neighboring AP with an overlapped area, and records detection messages sent by each terminal. Each AP also records the current user density (based on RSSI data) and the air interface usage of each user, and periodically reports the information to the home gateway. The home gateway analyzes the one (of 2 neighboring APs) overloaded with traffic or overloaded with users, analyzes terminals in the overlapped area of 2 neighboring APs, and directs the terminal that is connected to the overloaded AP to the AP with light load.

Figure 4-7 Working principle of AP steering

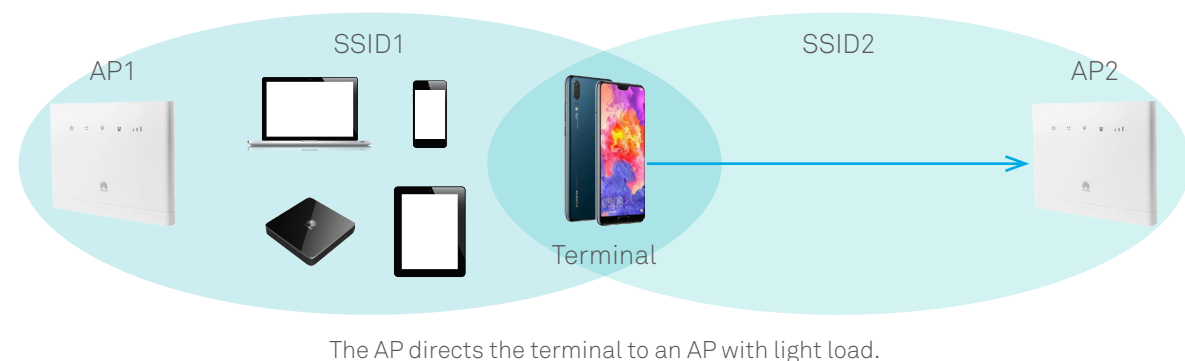

4.2.4 Intelligent Seamless Roaming

Seamless roaming technologies mainly include technologies as described in standards such as IEEE 802.11k, 802.11v, and 802.11r. The 802.11k standard helps an STA measure other APs' signal strength to make roaming decisions. The 802.11v standard allows STAs to roam to specified channels and basic service set identifiers (BSSIDs). The 802.11r standard eliminates the need of renegotiation on the key during roaming, which saves the roaming switching time.

Figure 4-8 Intelligent seamless roaming

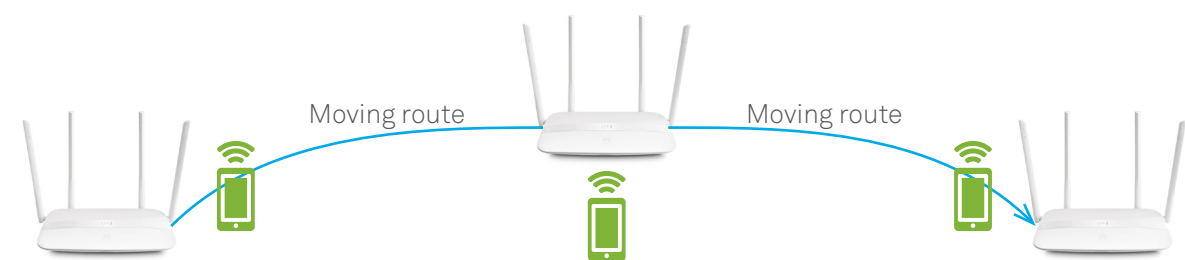

Key Features of 4K over Wi-Fi

The 802.11k and 802.11v intelligent seamless roaming technologies have been supported by most terminals. Many terminals do not immediately switch to an AP with the strongest signal when moving. The gateway or AP needs to trigger roaming switching to improve network performance. An AP detects the terminal RSSI, sending success rate, and rate. If these indicators are lower than the thresholds, the terminal is going far away from the AP. Then the AP instructs the terminal to trigger roaming. Based on the RSSI strength, cascading level, backhaul path, and load, the AP selects the optimal target AP for the terminal. The terminal switches to the optimal target AP as instructed.

For a terminal that does not support 802.11k, when an AP detects that a terminal can connect to another AP with better signal quality, the AP can force the terminal to go offline and to connect to the target AP by means of admission control of the target AP.

4.2.5 Baseband Beamforming

Figure 4-9 Working principles of beamforming

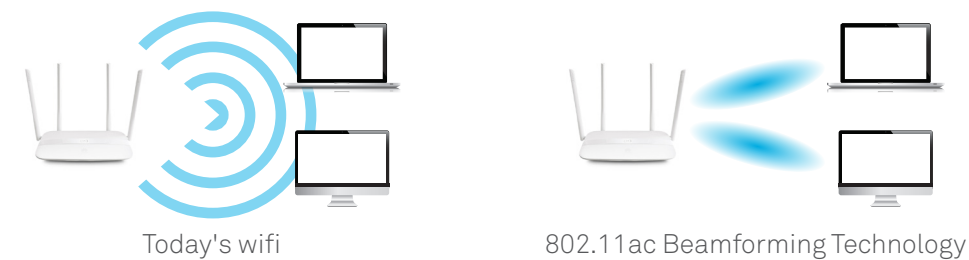

The beamforming technology is a part of the 802.11n and 802.11ac protocols. It is called Tx Beamforming in the protocols. An AP obtains the basic channel information of a terminal through protocol interaction. A baseband chip computes the phase difference between different antenna spatial flows to the terminal according to the basic channel information. Multiple antennas are used to transmit the same data symbols, but the data symbols of different antennas use different phase amplitudes for transmission. In this way, phases of multiple antenna signals are superimposed in different directions to present different strength, so that signal power in a specific receive-end direction is maximized. Because each antenna transmits the same data symbol, the diversity gain is obtained.



### 4.2.6 Intelligent Antenna Selection

Figure 4-10 Working principle of smart antenna selection

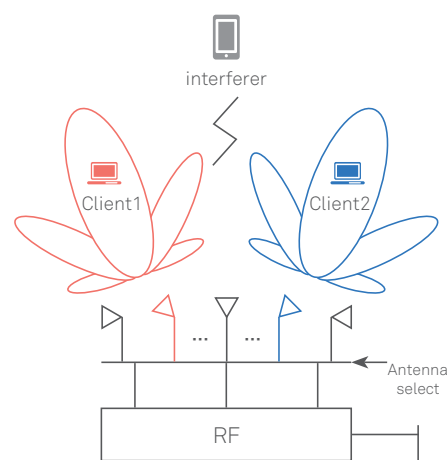

Similar to baseband beamforming, intelligent antenna technologies use the difference of hardware antennas to direct energy to different terminals.

1. Different omnidirectional antennas in an antenna array have different positions. Signals sent from the omnidirectional antennas have paths (of different length) to a specific terminal, and therefore the arrival time is different (phase difference). When the transmission phase is the same, some antennas play a positive role in receiving signals of a specific terminal, and some antennas play a negative role. For different terminals, an antenna combination with strongest signals can be selected.

2. For directional antennas, the signal gain in a specific direction is far greater than that of omnidirectional antennas. Several antennas in an antenna array are designed with different directivity. For terminals in different directions, an optimal combination of directional antennas can be selected to significantly improve the equivalent isotropically radiated power (EIRP) for specific terminals.

A gateway or AP has a historical database which records historical information about an antenna combination for each home terminal. After a terminal goes online, an optimal antenna combination is selected according to the historical information for the terminal.

Data to different terminals is sent by using the optimal antenna combination of each terminal.

A gateway or AP periodically sends detection signals from each antenna to a terminal, analyzes the advantages and disadvantages of each antenna about the terminal, selects the optimal antenna combination, and updates the historical database.

When the location of a terminal is changed, the RSSI can be decreased to trigger the re-selection of an optimal antenna combination.

Compared with baseband beamforming, intelligent antenna selection does not require protocol packet exchange to obtain wireless channel parameters. Therefore, antenna diversity gain can be obtained in low-speed scenarios, and antenna multiplexing gain can be also obtained in scenarios with a high speed and multiple spatial streams.

### 4.2.7 Airtime Fair Scheduling

Airtime fair scheduling is to schedule the wireless channel usage time of a service type of each terminal over the same radio frequency. It aims to ensure that the same service of each terminal occupies a wireless channel in a relatively fair mode. The traditional AP air interface scheduling mode is based on a first in first out (FIFO) queue, which has the following disadvantages:

- If a single terminal occupies a large number of downstream bandwidths, it can be difficult for other terminals to obtain sufficient bandwidths.
- Some low-speed terminals using old systems (802.11b/g) occupy too many air interface resources. As a result, the overall air interface throughput decreases.

For a specific service queue, airtime fair scheduling has the following improvements compared with FIFO queue scheduling:

- A scheduler allocates the same air interface time token to each terminal in each period. For a new packet to be sent, the scheduler estimates the air interface usage time required by the packet and subtracts the current number of tokens of the destination terminal.
- When the scheduler sends packets to the air interface, the packets are arranged in descending order according to the number of remaining time tokens of each terminal. Each time the scheduler sends packets, it preferentially sends the packet that occupies the least time (the most remaining time tokens) of the air interface in the current period for the corresponding terminal.
- The scheduler periodically reallocates time tokens to ensure long-term statistical fairness.

### 4.3 Maintainability and Manageability

Home Wi-Fi networks must be maintainable, operable, and manageable to bring benefits to carriers. The O&M and management capabilities include fault diagnosis and fault demarcation.

Fault diagnosis refers to the capability to remotely collect fault information and analyze and locate faults based on fault information when a home Wi-Fi network is abnormal.

Fault demarcation refers to the capability to obtain fault information and determine whether a fault is located on the upstream interface, Wi-Fi AP device, or a Wi-Fi line based on the fault information. With this capability, the fault scope can be narrowed down to quickly recover the network.

### 4.4 4K over Wi-Fi Solution

#### 4.4.1 Typical Networking of 4K over Wi-Fi

This document mainly discusses the possible Wi-Fi networking schemes of 4K VOD in home scenarios. The 4K VOD networking schemes vary depending on house structures (such as single-bedroom, three-bedroom, skip-floor, and villa).

**Single-AP networking scheme:** A single channel of Wi-Fi signal has a limited wall-through distance. Therefore, the single-AP networking scheme is suitable for families with small areas. Wired connections are difficult to implement because cable layout is involved. When VOD is required in multiple places of a home, wireless connection is a good choice.

Figure 4-11 Single-AP networking scheme

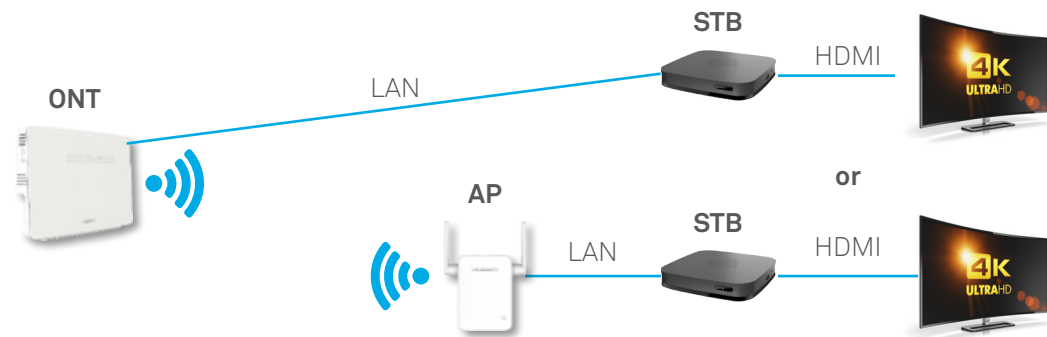

**Video bridge networking solution:** Dedicated 4K video bridge devices are used to carry video services. In addition, specific optimization can ensure high video quality and effectively expand house coverage.

Figure 4-12 Video communication networking scheme

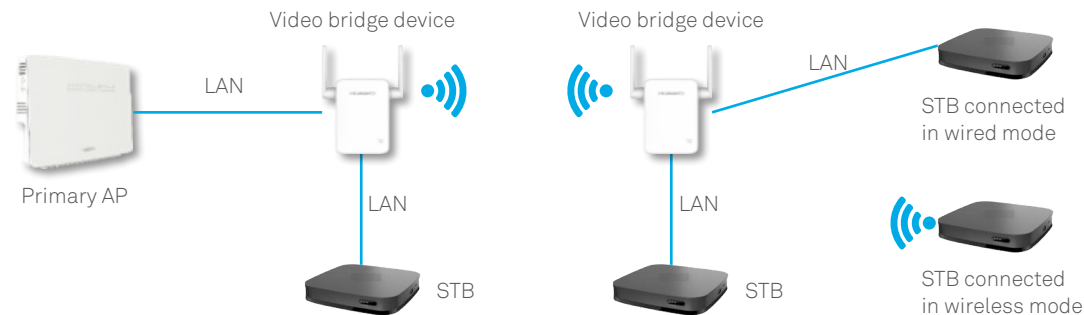

**Distributed networking scheme:** In scenarios such as villas and large houses, multiple tri-band APs are cascaded to implement Wi-Fi 300M full-coverage in all corners of the home and provide high-quality 4K connection access.

Figure 4-13 Distributed networking scheme

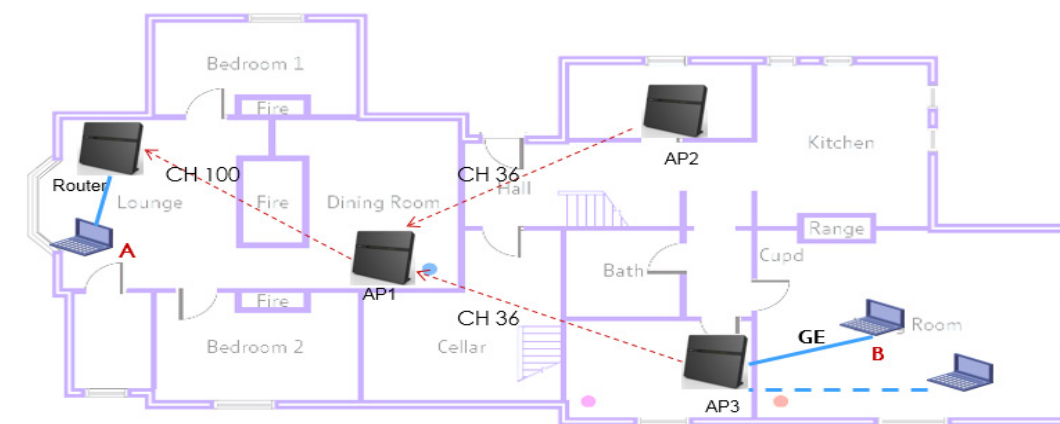

#### 4.4.2 Key Technologies of 4K over Wi-Fi

A home Wi-Fi network should be a video sensing network that provides premium video experience. As described in the preceding sections, video services have high requirements on packet loss rate and latency. The key to improving the experience of video over Wi-Fi lies in idle and exclusive channels, QoS for ensuring the IPTV priority, retransmission if applicable, and dynamic adjustment and intelligent sensing of video bandwidths.

##### QoS Scheduling for the Priority of Video Services

Figure 4-14 shows the overall QoS framework of a home gateway.

Figure 4-14 QoS scheduling for the priority of video services

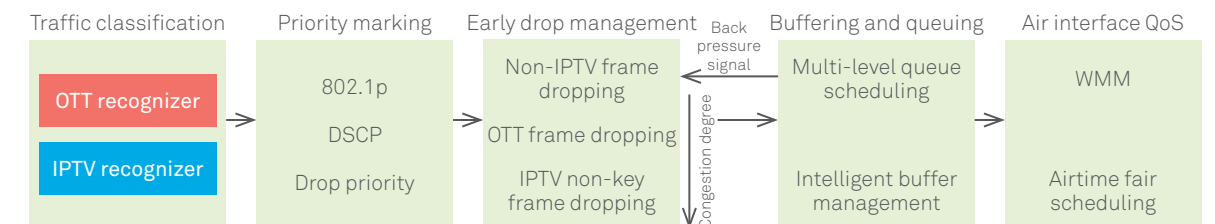

It is assumed that the home gateway can connect to an STB with the built-in Wi-Fi function through a Wi-Fi frequency band. For videos, the air interface channel in the downstream direction is a bottleneck. If the video services cannot exclusively occupy the downstream wireless channel, the QoS mechanism must be used to ensure that video packets can be preferentially sent.

The traffic classification module identifies multiple IPTV video streams, OTT video streams, and key video frames. The priority marking module marks 802.1p or DSCP values according to rules and marks less important frames that can be discarded.

The early drop management module starts early drop according to the back-end congestion degree. As the congestion intensifies, the packets at the tail of a queue are discarded according to the priority of each service, terminal, and SSID.

For the buffering and queuing module, the queue length, scheduling priority, weight, and queue rate limit are configured for each service of each terminal. The length of a UDP-based IPTV service queue must be as large as possible. The length of a TCP-based OTT video queue must be equal to the two-way latency (current 50 ms) of mainstream OTT carriers.

802.11e is the standard of Wi-Fi QoS. It stipulates a WMM mechanism. WMM defines 4 access categories (ACs), and 4 queues (voice, video, best effort, and background queues) in descending order of priority. This mechanism is used to ensure that packets with higher priorities preferentially preempt wireless channels and are preferentially sent.

WMM also defines a series of enhanced distributed channel access (EDCA) parameters for channel competition of various services:

- Arbitration interframe spacing number (AIFSN): A larger AIFSN value indicates a longer wait time of a service type. A shorter wait time indicates more opportunities of obtaining a channel.
- Exponent form of CWmin (ECWmin) and Exponent form of CWmax (ECWmax): They determine an average backoff time. Larger CWmin and CWmax values indicate a longer average backoff time of the service type when a conflict occurs.



Key Features of 4K over Wi-Fi

- A transmission opportunity (TXOP): It is the maximum duration of a channel that can be occupied by a service type after a competition success.

For a video service, small AIFSN/ECWmin/ECWmax and large TXOP can be configured to ensure a high air interface priority.

The multi-user multiple-input multiple-output (MU-MIMO) technology with 802.11AC wave 2 enables a gateway to transmit multiple data streams to different user terminals at the same time. The downstream MU-MIMO uses the zero forcing algorithm at the receive end to separate data streams sent to different terminals, or uses the beamforming method at the transmit end to separate data streams for different terminals before the data streams are sent (this simplifies operations at the receive end). If the home gateway and STB (or STB AP) support the MU-MIMO technology, this technology can be enabled to maximize the gain for the STB (or STB AP) to receive signals.

Call Admission Control (CAC) and Air Interface Time Guarantee for the Priority of Video Services

If video services cannot use a separate radio channel, it is necessary to grant the highest priority to the video services during channel sharing. For example, when a home gateway is cascaded with an STB AP through a 2.4G channel and multiple other terminals are connected to the home gateway through this channel, the home gateway needs to increase the time slice scheduling weight of the STB AP (considered a terminal connected to the home gateway in the 2.4G band) upon detection of STB power-on.

WMM CAC mechanism:

- A terminal needs to obtain the permission of an AP or home gateway before sending high-priority voice and video packets in the upstream direction. Therefore, after detecting that the STB is powered on, the home gateway allows only the STB or STB AP to send voice and video packets in the upstream direction, and other terminals are not allowed to send the packets of these 2 types. This prevents competition with video packets in the downstream direction of the air interface of the home gateway.
- When the BER of signals received by an STB or STB AP deteriorates, low-speed terminals and terminals with poor quality of received signals are forced to go offline to prevent these terminals from hindering downstream video services.

Video Retransmission Technology

IPTV live services are carried in UDP mode and sensitive to packet loss. 4K entails continuous heavy traffic and high throughput requirement. Video retransmission is required to ensure that packets are retransmitted in a timely manner when a large number of packets are lost on the home Wi-Fi air interface.



Key Features of 4K over Wi-Fi

Figure 4-15 Video retransmission mechanism

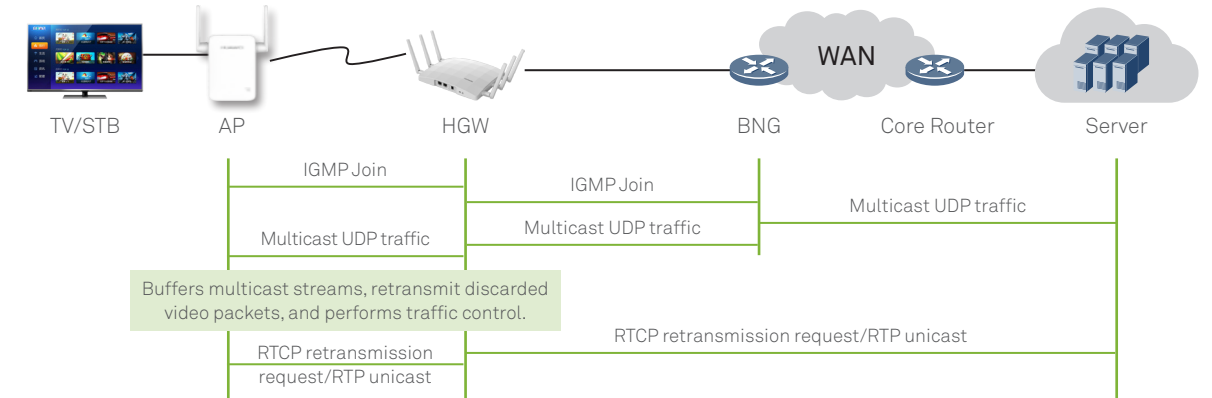

The gateway and AP buffer RTP packets and send requests to retransmit discarded video packets, reducing the requirement on the latency of the Wi-Fi network.

When RTP packets are retransmitted, the priority of the packets needs to be increased to reduce the forwarding latency.

VABA Intelligent Video Bandwidth Adjustment Technology

Video aware bandwidth adjustment (VABA) is an intelligent video bandwidth adjustment technology. It solves the problem that UDP video packets are randomly lost when queues are congested.

The VABA algorithm intelligently detects Wi-Fi link congestion and dynamically adjusts video program bandwidths to solve the problem of frame freeze caused by queue congestion of 4K video programs.

Figure 4-16 VABA algorithm formula

$$\text{drop } P_i \xrightarrow{\text{yields}} \max QoE\{U_{n \neq i}(P_n)\}$$

Figure 4-17 shows the comparison before and after VABA is enabled.

Figure 4-17 Comparison before and after VABA is enabled

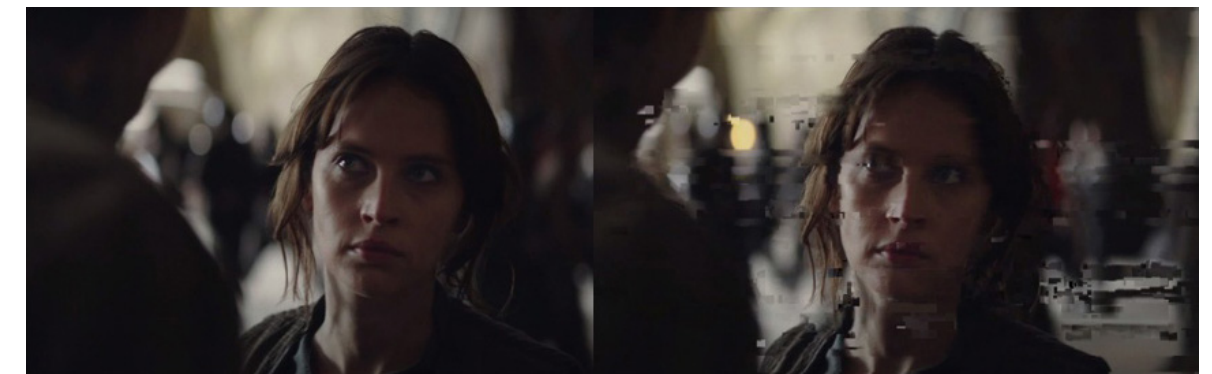

# 05 Deployment Suggestions for Typical Scenarios

## 5.1 Huawei SmartWi-Fi Home Network Solution Product Portfolio

Figure 5-1 shows the product portfolio of Huawei SmartWi-Fi home network solution.

Figure 5-1 Huawei SmartWi-Fi home network solution product portfolio

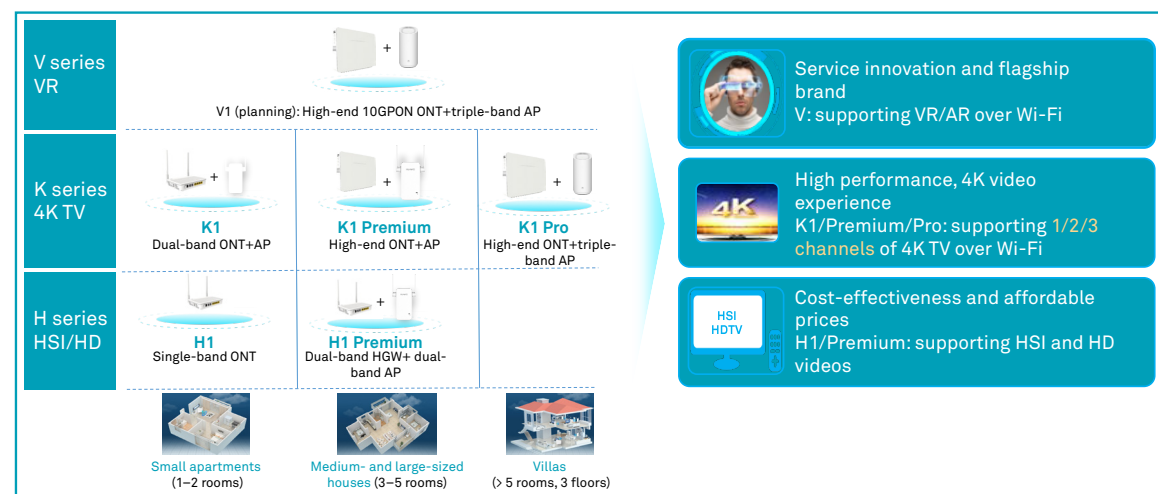

## 5.2 Small Household (1–2 Rooms)

Household characteristics: Small household, usually with 1–2 rooms.

User characteristics: The living room and the master bedroom have TV sets. In the living room and bedrooms, there are 1–2 non-video users.

Interference characteristics: Interference sources include the top, bottom, left, right, rear, front of the local building. The interference from the front and rear can be ignored if there are other apartments in the local building between the local apartment and the front and rear buildings. Apartments

Figure 5-2 Deployment in small household scenarios



on different floors of the front building also have interference, and there are many layers of a high-rise residential building. The number of interference sources is greater than 30.

Solution requirements: One ONT (HS8245W) can cover all areas of the household, and one 4K program service is supported.

## 5.3 Large Household (3–5 Rooms)

Household characteristics: Generally, there are 3–4 rooms.

User characteristics: The living room and the master bedroom have TV sets. In the living room and bedrooms, there are about 5 non-video users.

Interference characteristics: Interference sources include the top, bottom, left, right, front, and rear of the building. Apartments on different floors of the front and rear buildings also have interference. The number of interference sources is more than 20, and each interference source has 1–2 APs.

Solution requirements: The indoor area is large and signals need to pass through 2 or more walls. Two APs need to be deployed to support two to three 4K program services and 1x HS8245W + 2 x WA8011Y.

Figure 5-3 Deployment in large household scenarios



## 5.4 Skip-Floor Villa

Household characteristics: Detached or semi-detached villa, 2–3 floors, and 5–6 rooms.

User characteristics: The living room and multiple bedrooms have TV sets, requiring multi-level cascading. In the living room and bedrooms, there are about 10 non-video users.

Interference characteristics: The interference sources come from another villa sharing the wall with the local villa and come from neighboring villas, and the interference is relatively small. The number of interference sources is about 10. For each interference source, multiple APs need to be deployed.

Solution requirements: For example, each floor has 2–3 rooms. Each layer requires 1–2 tri-band APs. In Wi-Fi repeater mode, there is a strong requirement for tri-frequency APs to pass through the floor. Multi-level AP cascading is required. Multi-level cascading has high requirements on network topology stability. At least three to four 4K program services must be supported, strength of signals between APs must be  $-65$  dBm, and 1 x HS8245W + 3 x WA8011Y are supported.

Figure 5-4 Deployment in skip-floor villa scenarios



# 06

## Test Standards for 4K over Wi-Fi

### 6.1 Test Method

#### 6.1.1 Influencing Factor

In 4K over Wi-Fi testing, the following factors may cause 4K video freeze:

- Latency and packet loss from the video headend to the Wi-Fi device (the test can be performed by using an independent video headend and network impairment emulator to prevent the Internet from affecting the test result)
- Number of 4K videos connected to the Wi-Fi device
- Signal strength of video STAs
- Bit rate of 4K videos
- Number of STAs connected to the Internet
- Signal strength of STAs connected to the Internet
- Traffic of STAs connected to the Internet
- Number of interfering Wi-Fi devices
- Working channel of interfering Wi-Fi devices
- Signal strength of interfering STAs
- Video traffic of interfering STAs
- Internet access traffic of interfering STAs

#### 6.1.2 Test Environment

Wi-Fi test environments include the instrument environment, shielded environment, office environment, and home environment.

The instrument environment and shielded environment can prevent uncontrollable interference. Quantitative interference can be added. The test results have good repeatability. Intuitively, however, there is a difference from actual application scenarios.

The office environment has good availability, but the interference is uncontrollable. The test results have poor repeatability.

The home environment depends on the surrounding interference. For a detached villa in the suburb without houses around, the test results have good repeatability. For a common residential cell, there is a large amount of interference around. It is almost impossible for all neighbors to stop using Wi-Fi. Therefore, the test results have poor repeatability.

To ensure the repeatability and fairness of test results, it is recommended that quantitative and controllable interference is constructed in a shielded environment for testing 4K over Wi-Fi.

#### 6.1.3 Test Networking

Figure 6-1 shows the test networking of 4K over Wi-Fi.

Figure 6-1 Test networking of 4K over Wi-Fi

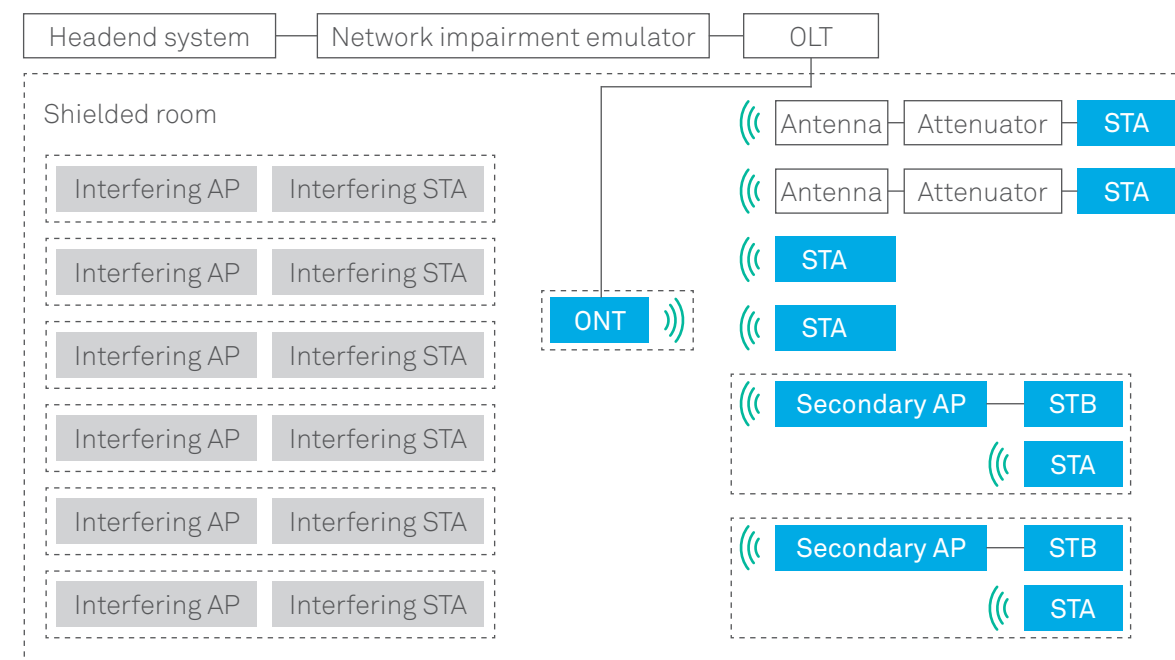

## 6.2 Typical Test Scenarios

Table 6-1 provides recommended test parameters in typical test scenarios.

Table 6-1 Recommended test parameters in typical test scenarios

Parameter	Scenario 1	Scenario 2	Scenario 3	Scenario 4
Latency	20 ms	20 ms	20 ms	20 ms
Number of 4K video channels	1	1	2	2
Signal strength of video STAs	-65 dBm	-65 dBm	-65 dBm	-65 dBm
4K video bit rate	Average bit rate: 30 Mbit/s Peak bit rate: 50 Mbit/s	Average bit rate: 30 Mbit/s Peak bit rate: 50 Mbit/s	Average bit rate: 30 Mbit/s Peak bit rate: 50 Mbit/s	Average bit rate: 30 Mbit/s Peak bit rate: 50 Mbit/s
Number of STAs connected to the Internet	1	2	1	2
Signal strength of STAs connected to the Internet	-72 dBm	-72 dBm	-72 dBm	-72 dBm
Traffic of STAs connected to the Internet	10M	10M	10M	10M
Number of interfering Wi-Fi devices	2	4	2	4
Working channel of interfering Wi-Fi devices	1 x same-channel + 1 x adjacent channel	2 x same-channel + 2 x adjacent channel	1 x same-channel + 1 x adjacent channel	2 x same-channel + 2 x adjacent channel
Signal strength of interfering STAs	-65 dBm	-65 dBm	-65 dBm	-65 dBm
Video traffic of interfering STAs	60M	120M	60M	120M
Internet access traffic of interfering STAs	20M	40M	20M	40M

- Android-system 4-bar signal strength indication is used as reference:
  - 4 bars: signal strength greater than or equal to -65 dBm
  - 3 bars: signal strength between -66 dBm and -72 dBm
  - 2 bars: signal strength between -73 dBm and -79 dBm
  - 1 bar: signal strength between -80 dBm and -85 dBm
  - 0 bars: signal strength less than or equal to -86 dBm
- The preceding table only provides examples in typical test scenarios. In practice, more test parameter combinations can be used.

# Outlook 07

End users' pursuit of better service experience is endless. Higher definition, more screens, and more viewing modes will promote the growth of video traffic. Video occupies 60% of the current network traffic and will continue to grow to 85% in the future.

Figure 7-1 Endless pursuit of service experience

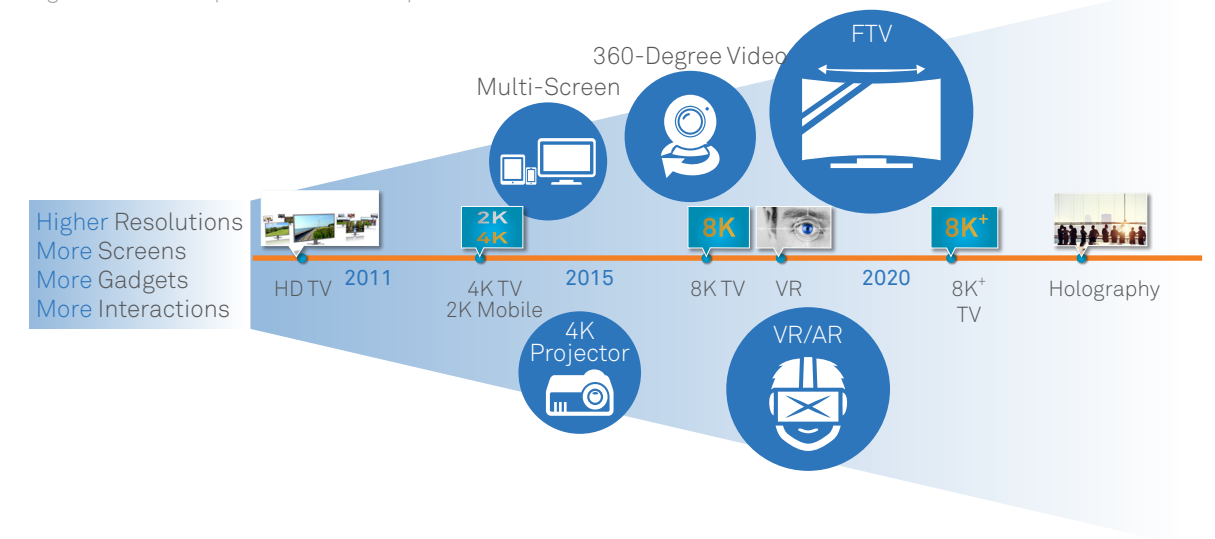

The development of 4K and higher-definition video services, the popularity of home multi-screen video services, and the increasing number of terminals pose increasing requirements on the Wi-Fi coverage, rate, and latency.

With the emergence of 4K video, 4K over Wi-Fi will become a universal requirement. In the next few years, 8K and VR videos will emerge. This requires future home Wi-Fi bandwidth and latency to support the development of UHD video services such as 8K and VR.



# 08

## References

1. TR 126: Triple-play Services Quality of Experience (QoE)
2. IEEE 802.11n, Higher throughput improvements using MIMO (multiple input, multiple output antennas)
3. IEEE 802.11ac, IEEE Standard for Telecommunications and Information Exchange Between Systems - LAN/MAN Specific Requirements - Part 11: Wireless Medium Access Control (MAC) and physical layer (PHY) specifications: High Speed Physical Layer in the 5 GHz band

# 09

## Acronyms and Abbreviations

Acronym and Abbreviation	Description
AP	Access point
GE	Network cable interface that supports an access rate of 1000 Mbit/s
HGW	Home gateway in the upstream direction of a network cable, which can work in routing or bridging mode
IPTV	Interactive network TV service
LAN	Local area network, also network cable interface or user-side interface
PLC	Power line communication modem
RTT	Round-trip time
SSID	ID of a wireless network
STA	Station
STB	Set-top box
TCP	Transmission Control Protocol
UDP	User Datagram Protocol
VABA	Video aware bandwidth adjustment
WAN	Wide area network, also service logical interface or network-side interface of a home gateway unit (HGU) or HGW
Wi-Fi	Wireless Fidelity, a wireless local area network (WLAN) technology to provide wireless access for wireless devices such as mobile phones and tablets